



 LIGHT
PRESTIGE

Spis treści

				Oprawy dekoracyjne					
					Midway Shiny 3	Midway 5	Ring 7	Hlifax 9	Dorado Gold 11
Dorado Black&White 13	Dorado 15	Dorado 17	Alisa 19	Roma 21	Puerto 23	Arette 25	Palla 27		
Lorenzo 29	Savona 30	Piega 31	Glamour 33	Miele 35-38	Manacor 39	Lungo 41	Tokio 43		
Malawi 45	Ferrara 47	Flower 49	Rope Light 51	Ibros 53	Reus Led 55	Reus 57	Reus Spot 59		
Frame 61	Arizona 63	Lugano 65	Burgo 67	Bovino 69	Solin 71	Solin Złoty 73	Canaria 75		
Tarragona 76	Sada 77	Carrara 79	Montana 80	Monza 80	Konstelacja 81	Treviso 83	Galaxy 85		
Galactico 87	Melt 89	Fondi 91	Niki 93	Rame 95	Jukon 97	Estrella 99	Soletto 101		
Napoli 103	Nola 104	Dritto 105	Jet 107	Delos 109	Madryt 110	Malaga 111	Bali 113		
Milk 115	Sunflower 117	Alto 119	Hudson 121	Marbella 123	Tamiza 125	Cecina 127	Dakota 128		
Casoli 129	Tivoli 130	Senise 131	Zig-zag 133	Vigo 135	Mona 137	Vetro 139	Vetro Gold 141		



Cristallo 143



Cantos 145



Grafitti 147



Rubi 149



Butterfly 151



Flowers 152



Farfalla 153



Futuro 155



Astama 157



Arezzo 158



Oregon 159



Alaska 160



Torino 161



Sapri 162



Georgia 163



Rapido 165



Loria 167



York 168



Snow 169



Snow Spot 171

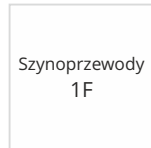

Szynoprzewody 1F



Snow 1F 173



Tokio 1F 175



Ice 1F 177



Storm 1F 179



Rocca 1F 181



Leon 1F 182



Bola 1F 183



Lungo 1F 183



Moon 1F 184



Aquilion 1F 184



Akcesoria 1F 185



Szynoprzewody 3F



Ice 3F 187



Magnum 3F 187



Lungo 3F 188



Moon 3F 188



Akcesoria 3F 189



Szynoprzewody MAGNETIC



Sun 191



Bilbao 192



Lunar 192



Star 193



Moon 194



Akcesoria Magnetic 195



Oprawy techniczne i łazienkowe



Platillo 197



Modern Slim 199



Mirror 201



Isla 203



Ibros 205



Denver 207



Cargo 208



Boston 209



Manacor 211



Faro IP65 213



Faro XL IP65 213



Kendal IP65 214



Metis 215



Lagos 216



Orion 216



Lyon 217



Tulon 218



Kendal 218



Lagos IP65 219

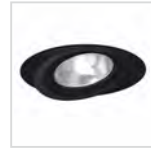

Nero 221



Camino 222



Żarówki 223



Taśmy LED 224





Clouds 225





MIDWAY SHINY

LP-033/1P L złoty Shiny

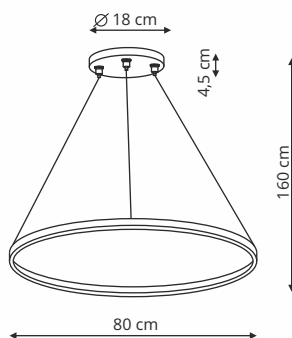
-  sz. 80 x gł. 80 x wys. 160 cm
-  metal - oprawa galwanizowana
-  1 x LED 30W, 3000K, 3300LM



LP-033/1P XL złoty Shiny

-  sz. 120 x gł. 120 x wys. 160 cm
-  metal - oprawa galwanizowana
-  1 x LED 65W, 3000K, 7050LM

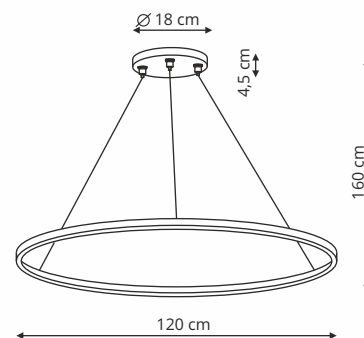

Złoty Shiny





MIDWAY

LP-033/1P S złoty

sz. 60,8 x gł. 60,8 wys. 126 cm

metal

1 x LED 35W, 3000K, 3850LM,

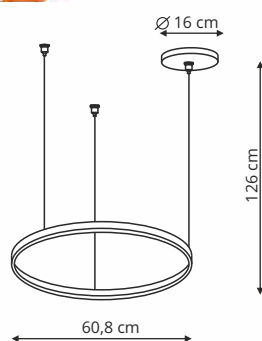

LP-033/1P L złoty

sz. 80,8 x gł. 80,8 wys. 126 cm

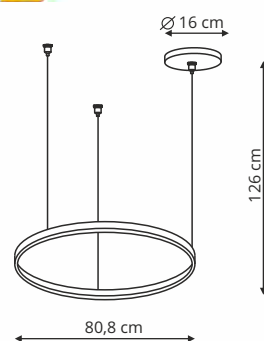

metal

1 x LED 40W, 3000K, 4600LM,





LP-033/1P S złoty Triangle
LP-033/1P S czarny Triangle

-  sz. 60 x gł. 60 x wys. 126 cm
-  metal
-  1 x LED 35W, 3000K, 3850LM

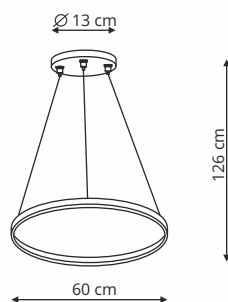



RING

LP-909/1C S plafon mały czarny

sz. 60 x gł. 60 wys. 16 cm

metal

1 x LED 26W, 1820LM,
dostępne w barwie światła
3000K lub 4000K

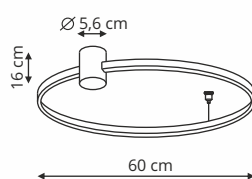

LP-909/1C L plafon duży czarny

sz. 90 x gł. 90 wys. 16 cm

metal

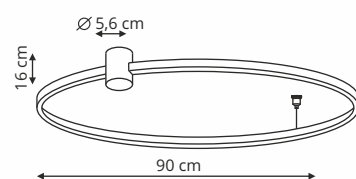

1 x LED 38W, 2600LM,
dostępne w barwie światła
3000K lub 4000K



Czarny





LP-909/1P S mała czarna

-  sz. 40 x gł. 40 x wys. 120 cm
-  metal
-  1 x LED 24W
dostępne w barwie światła
3000K lub 4000K





LP-909/1P M średnia czarna

-  sz. 66 x gł. 66 x wys. 120 cm
-  metal
-  1 x LED 40W
dostępne w barwie światła
3000K lub 4000K



LP-909/1P L duża czarna

-  sz. 80 x gł. 80 x wys. 120 cm
-  metal
-  1 x LED 48W, 3000K





HALIFAX

LP-940/2P 4BK

sz. 60 x gł. 80 x wys. 120 cm

metal, akryl

LED 45W 4000K, 2700LM

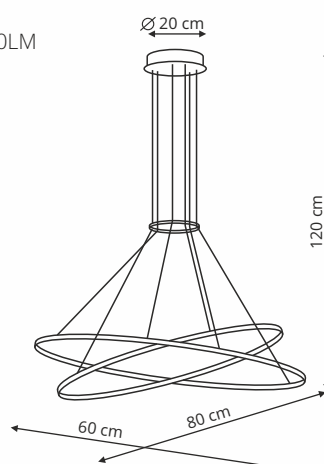



Czarny





DORADO

LP-002/4P

-  sz. 12 x gł. 87 x wys. 49,5 cm
-  metal, szkło
-  4 x G9, max 40W

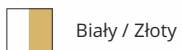
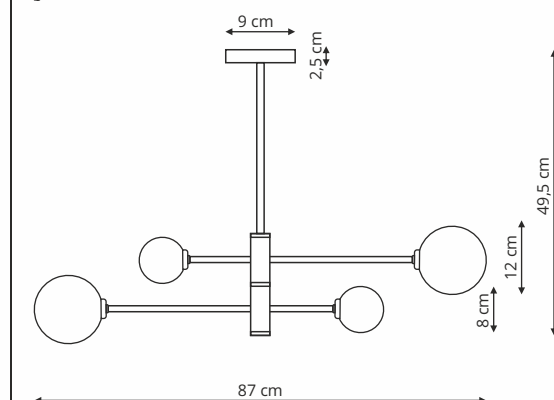



LP-002/6P

sz. 12 x gł. 87 x wys. 60 cm

metal, szkło

6 x G9, max 40W

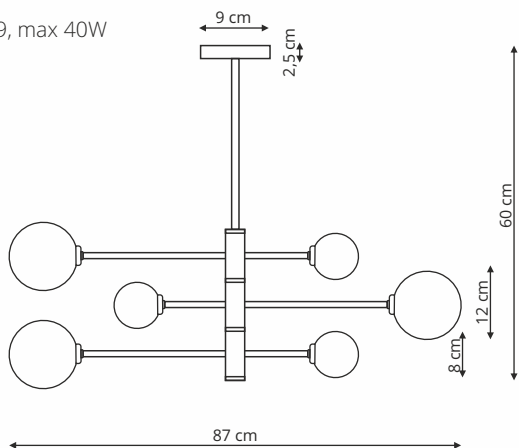

LP-002/8P

sz. 120 x gł. 36 x wys. 60 cm

metal, szkło

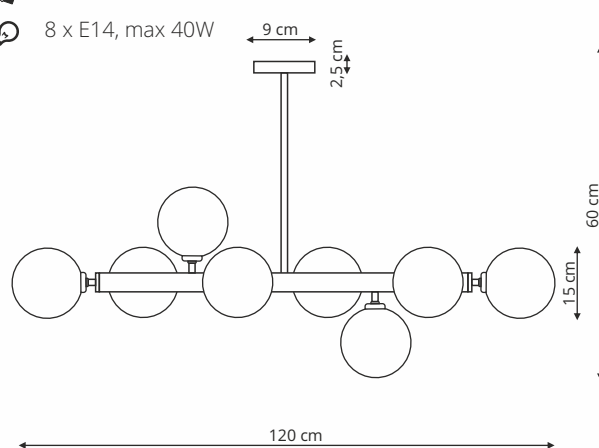

8 x E14, max 40W







DORADO

LP-002/4P

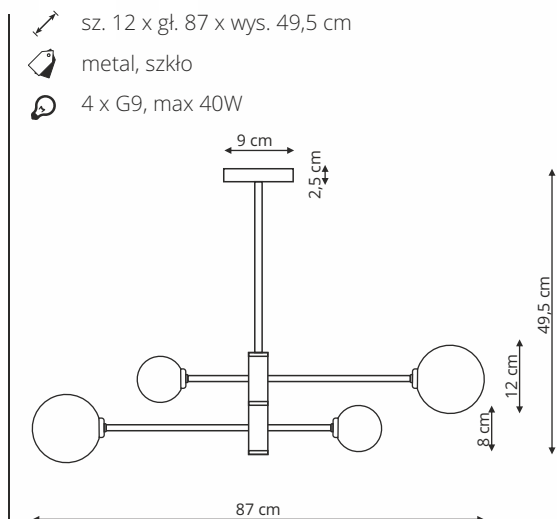
-  sz. 12 x gł. 87 x wys. 49,5 cm
-  metal, szkło
-  4 x G9, max 40W



 Biały / Czarny



LP-002/6P

sz. 12 x gł. 87 x wys. 60 cm

metal, szkło

6 x G9, max 40W

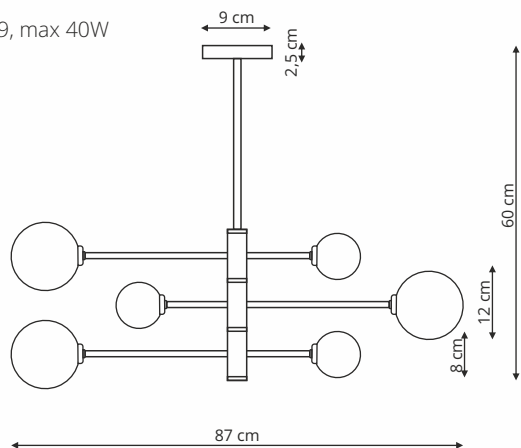

LP-002/8P

sz. 120 x gł. 36 x wys. 60 cm

metal, szkło

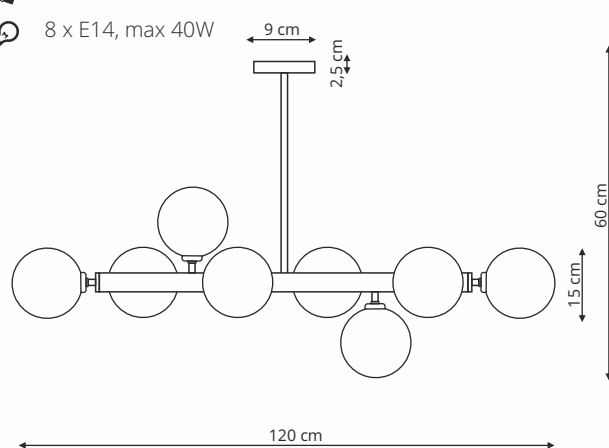

8 x E14, max 40W







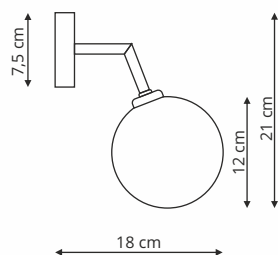

DORADO

LP-002/1W złota
LP-002/1W czarna

-  sz. 12 x gł. 18 x wys. 21 cm
-  metal, szkło
-  1 x G9, max 40W



LP-002/2W złota
LP-002/2W czarna

-  sz. 15 x gł. 20 x wys. 42 cm
-  szkło, metal
-  2 x G9, max 40W

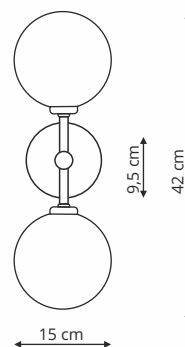



LP-002/6C złota

LP-002/6C czarna

📏 sz. 89 x gł. 80 wys. 18 cm

🪞 szkło, metal

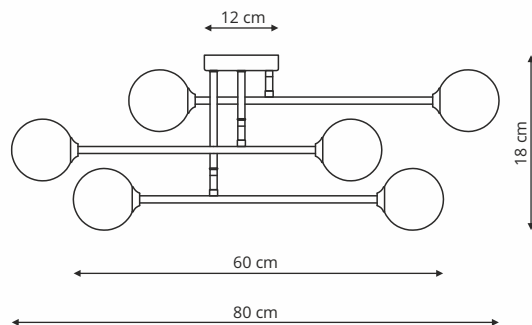
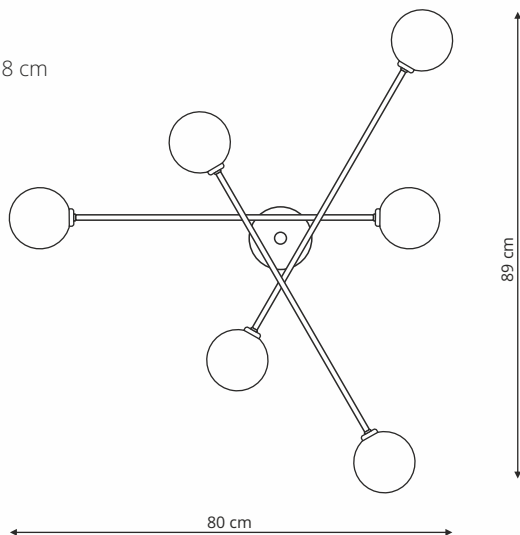

💡 6 x G9, max 40W







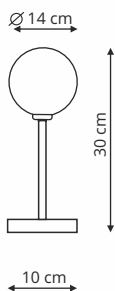

DORADO

LP-002/1T

-  sz. 14 x gł. 14 x wys. 30 cm
-  metal, szkło
-  1 x E14, max 40W



LP-002/2T

-  sz. 23 x gł. 23 x wys. 45 cm
-  metal, szkło
-  2 x E14, max 40W

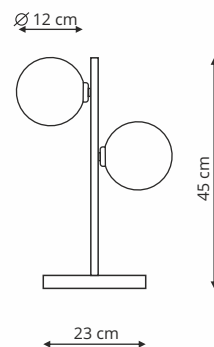



LP-002/3F

 sz. 33 x gł. 33 x wys. 160 cm

 metal, szkło

 3 x E14, max 40W

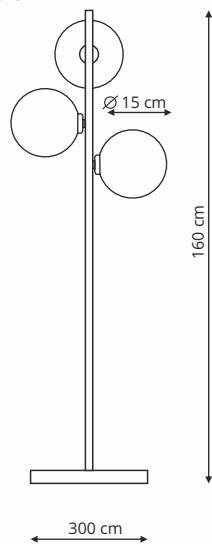



ALISA

- LP-005/6P złota / biała
- LP-005/6P złota / transparentna
- LP-005/6P czarna / biała
- LP-005/6P czarna / transparentna

↗ sz. 125 x gł. 39 wys. 78 cm

👁 szkło, metal

💡 6 x E14, max 5W LED

- Złoty / biały
- Złoty / Transparentny
- Czarny / Złoty
- Czarny / Transparentny

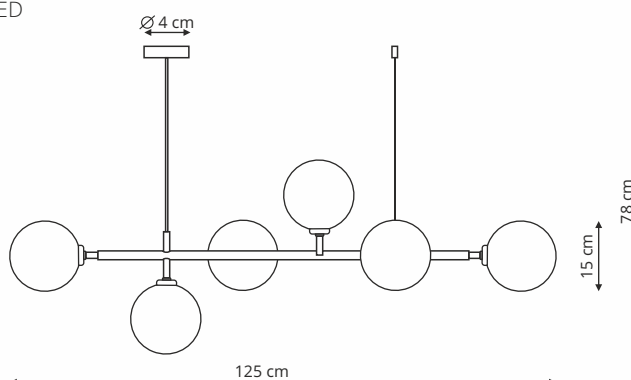



LP-002/2W złota / biała

LP-002/2W złota / transparentna

LP-002/2W czarna / biała

LP-002/2W czarna / transparentna

 sz. 15 x gł. 20 wys. 45 cm

 szkło, metal

 2 x E14, max 40W LED

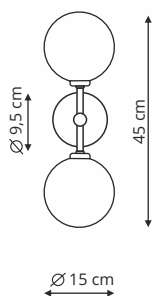

LP-002/2W L złota / biała

LP-002/2W L czarna / biała

 sz. 12 x gł. 16 wys. 46 cm

 szkło, metal

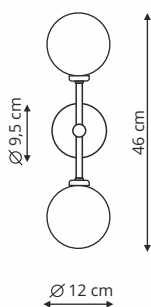

 2 x G9, max 5W LED







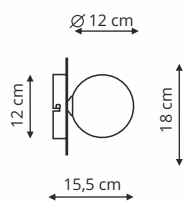

ROMA

LP-1345/1W złota LP-1345/1W czarna

-  sz. 18 x gł. 15,5 x wys. 18 cm
-  metal, szkło
-  1 x G9 LED, max 5W



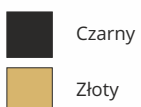
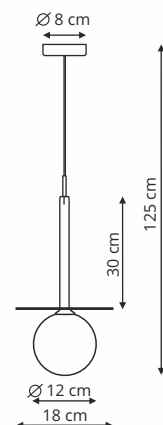

LP-1345/1P złota LP-1345/1P czarna

-  sz. 9,5 x gł. 9,5 x wys. 160 cm
-  metal, szkło
-  1 x E14 LED, max 5W





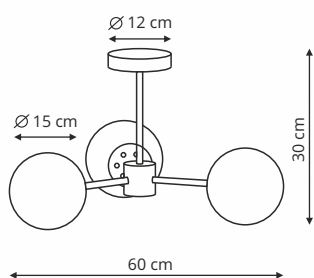

LP-1345/3P złota
LP-1345/3P czarna

-  sz. 60 x gł. 60 x wys. 30 cm
-  metal, szkło
-  3 x E14 LED, max 5W



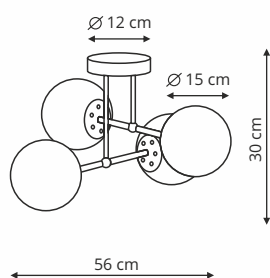

LP-1345/4P złota
LP-1345/4P czarna

-  sz. 56 x gł. 56x wys. 30 cm
-  metal, szkło
-  4 x E14 LED, max 5W



LP-1345/5P złota
LP-1345/5P czarna

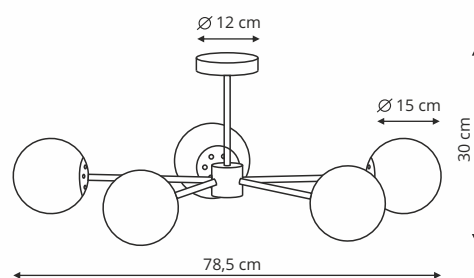

-  sz. 78,5 x gł. 78,5 x wys. 30 cm
-  metal, szkło
-  5 x E14 LED, max 5W







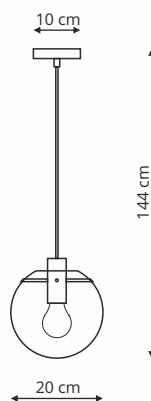

PUERTO

LP-004/1P S złota LP-004/1P S czarna

-  sz. 20 x gł. 20 x wys. 144 cm
-  metal, szkło
-  1 x E27, max 50W



LP-004/1P M złota LP-004/1P M czarna

-  sz. 25 x gł. 25 x wys. 150 cm
-  metal, szkło
-  1 x E27, max 50W

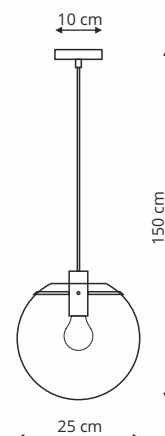



LP-004/1P L złota
LP-004/1P L czarna

🔧 sz. 30 x gł. 30 x wys. 155 cm

🔩 metal, szkło

💡 1 x E27, max 50W

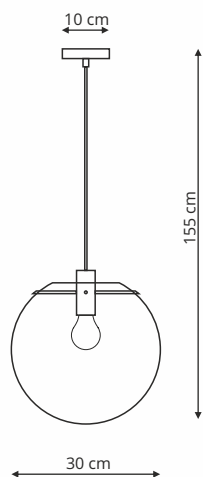

LP-004/3P złota
LP-004/3P czarna

🔧 sz. 30 x gł. 30 x wys. 155 cm

🔩 metal, szkło

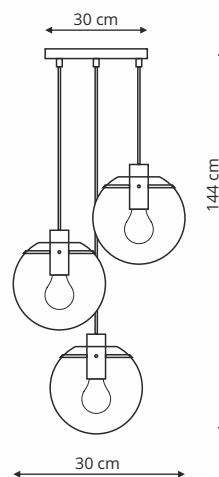

💡 3 x E27, max 50W







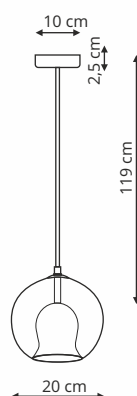

ARETTE

LP-133/1P

-  sz. 20 x gł. 20 x wys. 119cm
-  metal, szkło
-  1 x E27, max 60W



LP-133/3L

-  sz. 65 x gł. 20 x wys. 119 cm
-  metal, szkło
-  3 x E27, max 60W

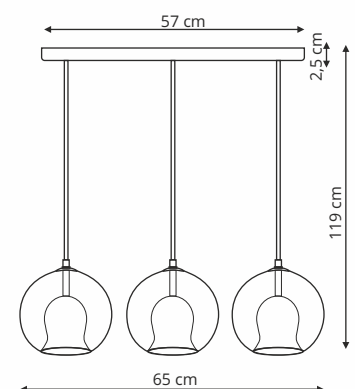

 Złoty





PALLA

LP-2844/1P chrom

LP-2844/1P złota

LP-2844/1P miedziana

 sz. 30 x gł. 30 x wys. 150 cm

 szkło, metal

 1 x E27, max 40W

Ø 8 cm

150 cm



 Chrom

 Złoty

 Miedziany



LP-2844/1P S chrom

LP-2844/1P S złota

LP-2844/1P S miedziana

 sz. 15 x gł. 15 x wys. 120 cm

 szkło, metal

 1 x E14, max 40W

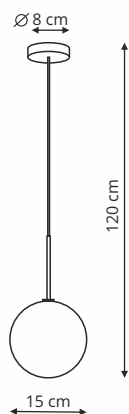



LORENZO

LP-2960/1W Chrom

LP-2960/1W Złota

 sz. 8 x gł. 10 x wys. 42 cm

 metal, szkło

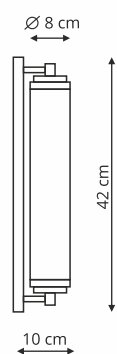

 2 x E14, max 40W







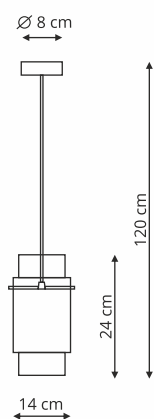

SAVONA

LP-707/1P

-  sz. 14 x gł. 14 x wys. 120 cm
-  metal, szkło
-  1 x E27, max 40W



LP-707/3L

-  sz. 58 x gł. 14 x wys. 120 cm
-  metal, szkło
-  3 x E27, max 40W

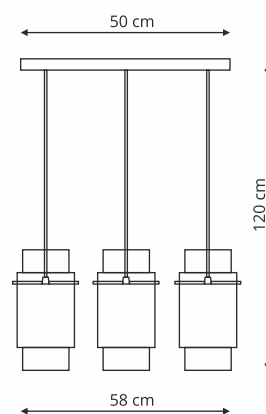

 Chrom



PIEGA

LP-939/1P bursztynowa
LP-939/1P biała
LP-939/1P dymna

- sz. 10 x gł. 10 x wys. 150 cm
- szkło, metal
- 1 x E14, max 40W

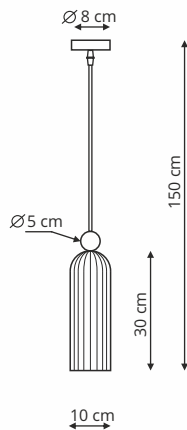

LP-939/3L bursztynowa
LP-939/3L biała
LP-939/3L dymna

- sz. 10 x gł. 55 x wys. 150 cm
- szkło, metal
- 3 x E14, max 40W

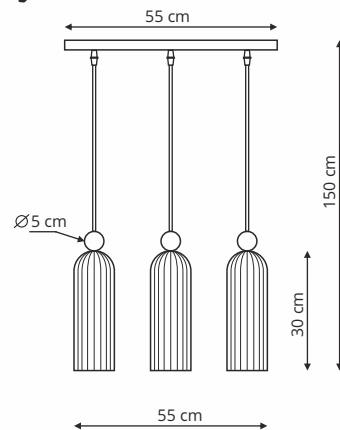



- Bursztyn
- Biała
- Dymny



LP-939/1W bursztynowa

LP-939/1W biała

LP-939/1W dymny

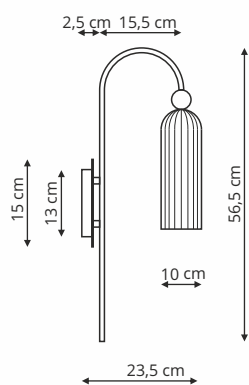

-  sz. 30 x gł. 30 x wys. 100 cm
-  szkło, metal
-  1 x E14, max 40W





GLAMOUR

LP-979/1W

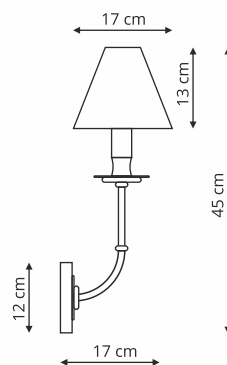

-  sz. 10,5 x gł. 17 x wys. 45 cm
-  metal, tkanina
-  1 x E14, max 40W



Czarny



LP-979/6P

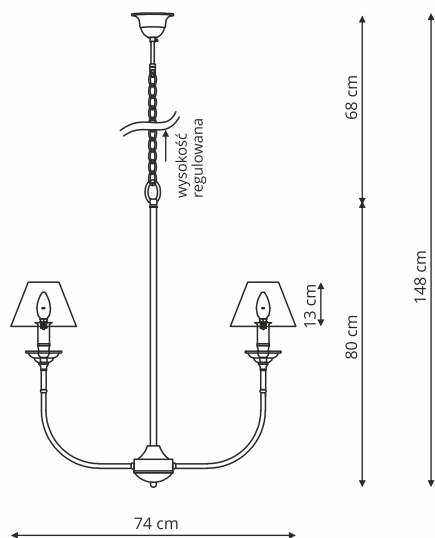

-  sz. 74 x gł. 74 x wys. 80 cm
-  metal, tkanina
-  6 x E14, max 40W







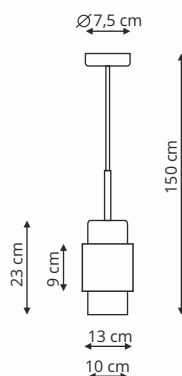

MIELE

LP-866/1P L SM Złota

-  sz. 13 x gł. 13 x wys. 150 cm
-  metal, szkło
-  1 x E27, max 40W



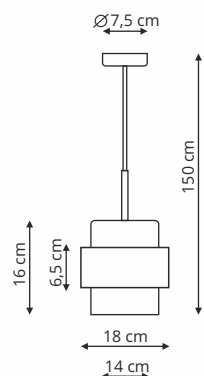

LP-866/1P SM Złota

-  sz. 18 x gł. 18 x wys. 150 cm
-  metal, szkło
-  1 x E27, max 40W





LP-866/3P SM Złota

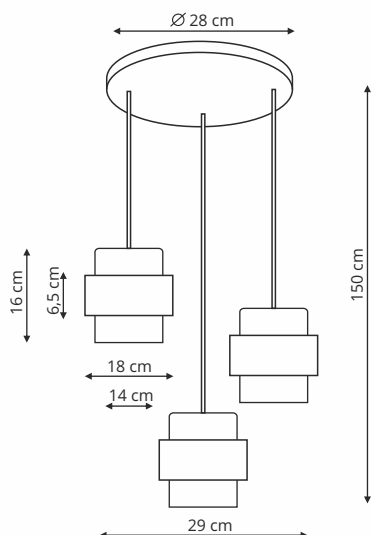

-  sz. 29 x gł. 29 x wys. 150 cm
-  metal, szkło
-  3 x E27, max 40W







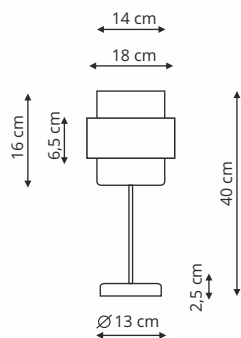

MIELE

LP-866/1T Złota

-  sz. 18 x gł. 18 x wys. 40 cm
-  metal, szkło
-  1 x E27, max 40W



LP-866/1W Złota

-  sz. 18 x gł. 18 x wys. 9 cm
-  metal, szkło
-  1 x E27, max 40W

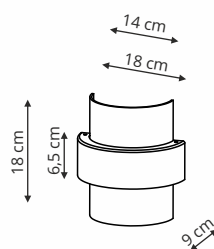

 Złoty







MANACOR



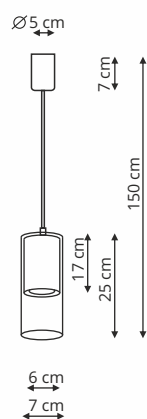

LP-232/1P biała
LP-232/1P czarna

-  sz. 7 x gł. 7 x wys. 150 cm
-  szkło, metal
-  1 x GU10, max 50W



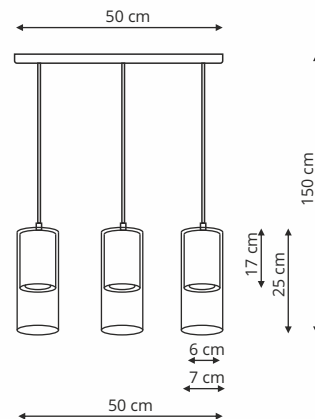

LP-232/3L biała
LP-232/3L czarna

-  sz. 50 x gł. 7 x wys. 150 cm
-  szkło, metal
-  3 x GU10, max 50W





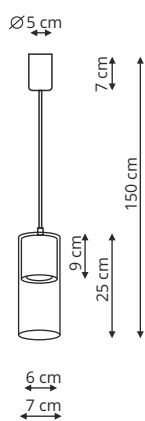

LP-232/1P złota

-  sz. 7 x gł. 7 x wys. 150 cm
-  szkło, metal
-  1 x GU10, max 50W



LP-232/3L złota

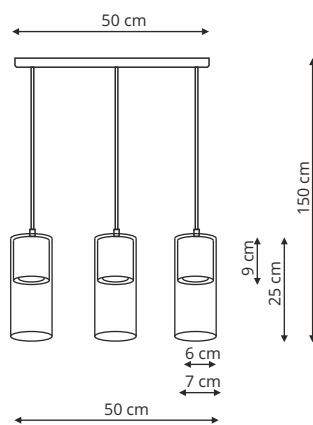

-  sz. 50 x gł. 7 x wys. 150 cm
-  szkło, metal
-  3 x GU10, max 50W







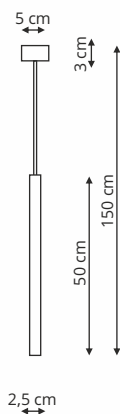

LUNGO

LP-894/1P złota
LP-894/1P czarna

-  sz. 2,5 x gł. 2,5 x wys. 150 cm
-  metal
-  1 x G9, max 5W



LP-894/7P złota
LP-894/7P czarna

-  sz. 30 x gł. 30 x wys. 150 cm
-  metal
-  7 x G9, max 5W

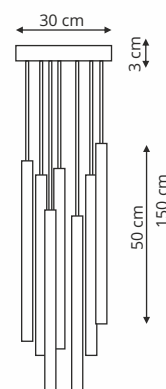









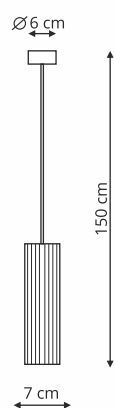

TOKIO

LP-787/1P Biała LP-787/1P Czarna

-  sz. 7 x gł. 7 x wys. 150 cm
-  metal
-  1 x GU10, max 50W



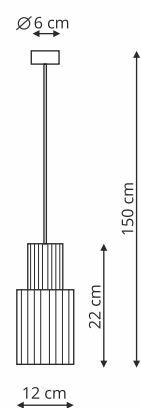

LP-787/1P L Biała LP-787/1P L Czarna

-  sz. 12 x gł. 12 x wys. 150 cm
-  metal
-  1 x E27, max 50W





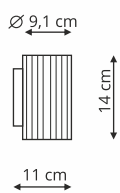

LP-787/1W Biała
LP-787/1W Czarna

-  sz. 9,1 x gł. 11 x wys. 14 cm
-  metal
-  1 x G9, max 40W



LP-787/2W Biała
LP-787/2W Czarna

-  sz. 7 x gł. 9 x wys. 30 cm
-  metal
-  2 x GU10, max 50W

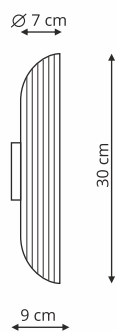

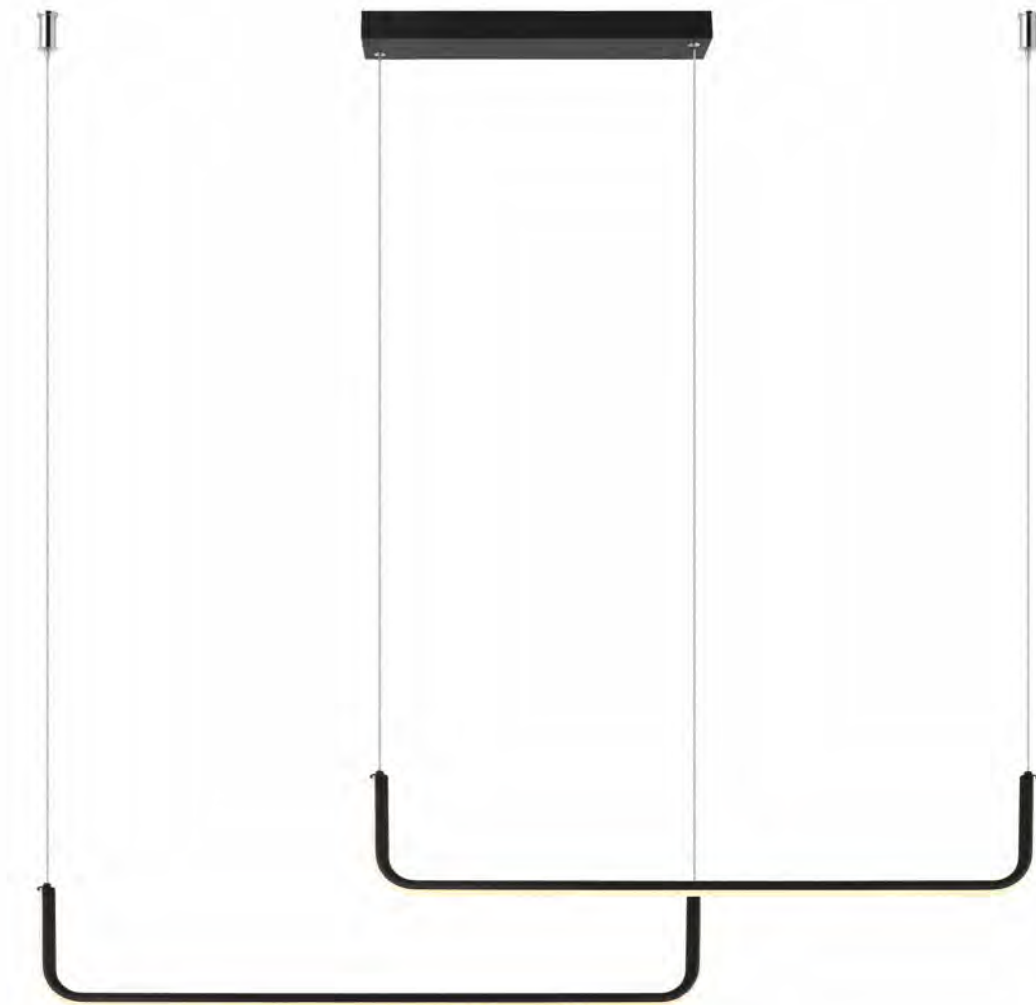

MALAWI

LP-1015/2P

 sz. 120 x gł. 20 x wys. 180 cm

 metal

 1 x LED, max 40W

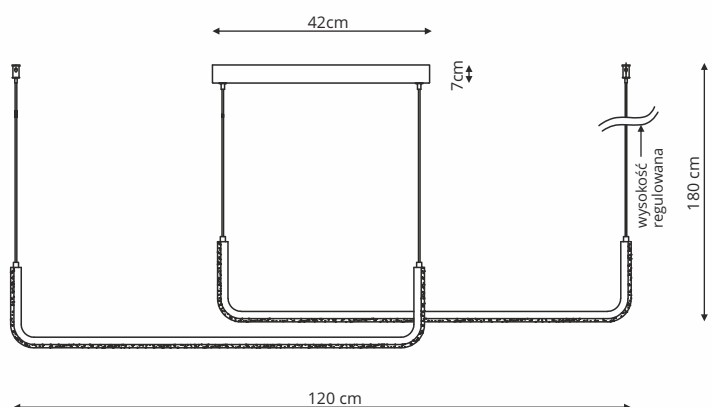

Czarny



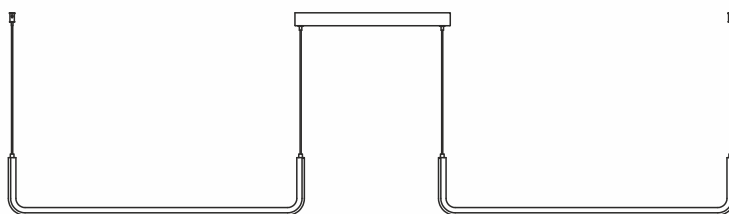
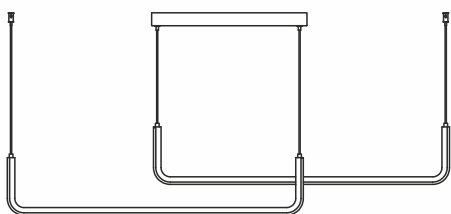
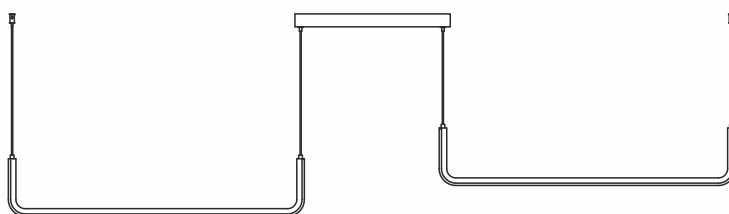
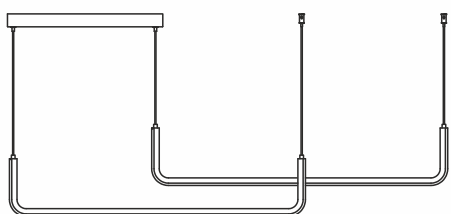

Możliwe układy montażu







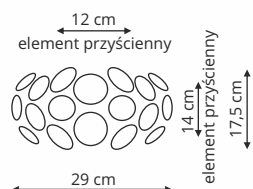

FERRARA

LP-17060/1W

-  sz. 29 x gł. 17 x wys. 17,5 cm
-  akryl, metal
-  1 x E14, max 60W



LP-17060/1C

-  sz. 25 x gł. 25 x wys. 22 cm
-  akryl, metal
-  1 x E14, max 60W

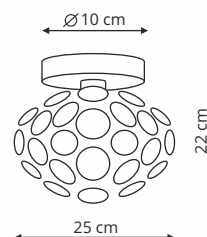

 Chrom



LP-17060/3C

- sz. 48 x gł. 48 x wys. 23 cm
- akryl, metal
- 3 x E14, max 60W

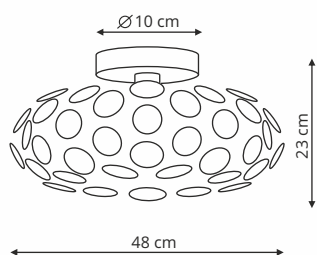

LP-17060/3P

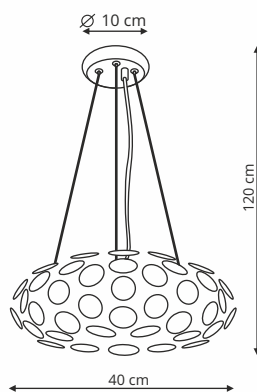

- sz. 40 x gł. 40 x wys. 120 cm
- akryl, metal
- 3 x E14, max 60W





FLOWER

LP-010/1P czarna

-  sz. 80 x gł. 80 x wys. 150 cm
-  metal
-  1 x E27, max 60W

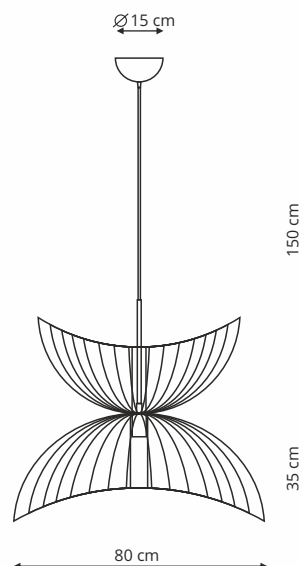

Czarny







ROPE LIGHT

LP-642/2M biała
LP-642/2M czarna
LP-642/2M złota

* Zasilacz lampy
montowany oddzielnie

-  dł. 200 cm
-  akryl, metal
-  1 x LED, max 50W, 6600LM, 3000K

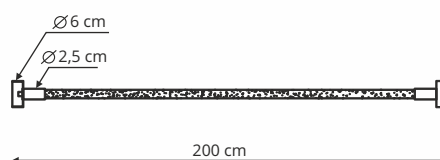
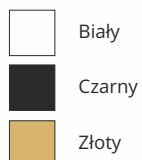



LP-642/3M biała
LP-642/3M czarna
LP-642/3M złota

-  dł. 300 cm
-  akryl, metal
-  1 x LED, max 73W, 9800LM, 3000K

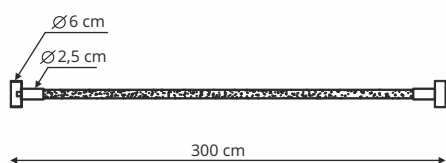

LP-642/4M biała
LP-642/4M czarna
LP-642/4M złota

-  dł. 400 cm
-  akryl, metal
-  1 x LED, max 97W, 13085LM, 3000K

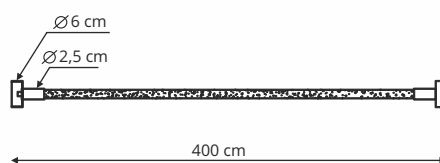

Dostępne kolory podsufitek

Biały



Czarny



Złoty







IBROS

Produkt posiada certyfikat



LP-7001/1P biały 63 18 LP-7001/1P czarny 63 18

-  sz. 63 x gł. 5,5 x wys. 8 cm (linka 150 cm)
-  metal, akryl
-  1 x LED 18W, 1440LM, dostępna w barwie światła 3000K lub 4000K

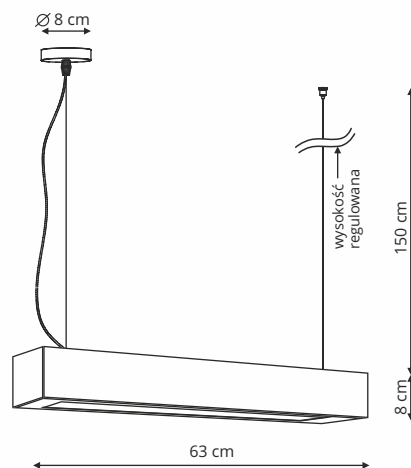

Biały



Czarny



LP-7001/1P biały 93 18

LP-7001/1P czarny 93 18

sz. 93 x gł. 5,5 x wys. 8 cm (linka 150 cm)

metal, akryl

1 x LED 18W, 1940LM,
dostępna w barwie światła
3000K lub 4000K

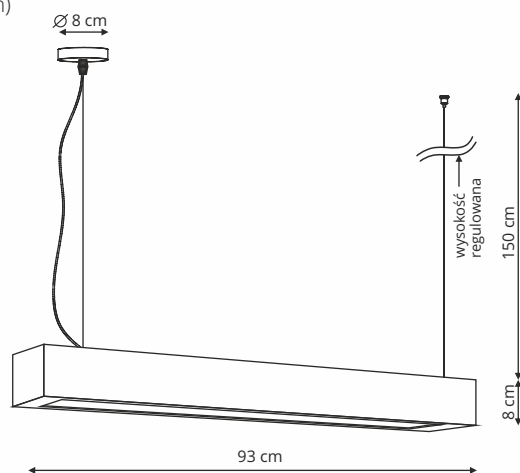



REUS

LP-8069/1P LED biała
LP-8069/1P LED czarna
LP-8069/1P LED złota

 sz. 61 x gł. 61 x wys. 100 cm

 metal

 1 x LED zintegrowany
 36W 4000K 3240LM



-  Biały
-  Czarny
-  Złoty

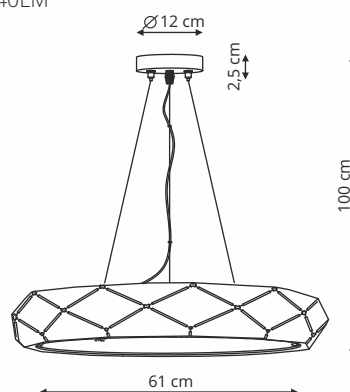



LP-8069/1C LED biała
LP-8069/1C LED czarna
LP-8069/1C LED złota

 sz. 61 x gł. 61 x wys. 9 cm

 metal

 1 x LED zintegrowany
36W 4000K 3240LM

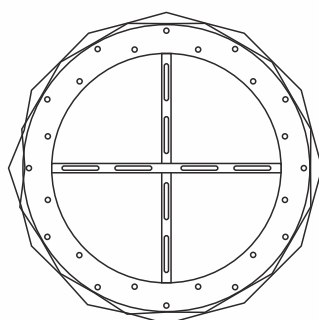

45 cm

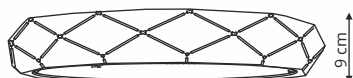

61 cm

9 cm



REUS

LP-8069/1P biała

LP-8069/1P złota

LP-8069/1P czarna

 sz. 47 x gł. 47 x wys. 120 cm

 metal, akryl

 3 x E27, max 40W

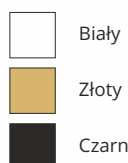
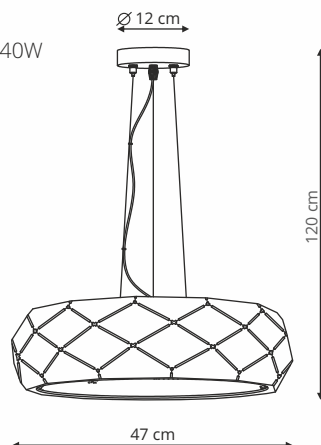



LP-8069/1W kinkiet biały
LP-8069/1W kinkiet złoty
LP-8069/1W kinkiet czarny

 sz. 36 x gł. 15 x wys. 13,5 cm

 metal, akryl

 1 x E27, max 40W

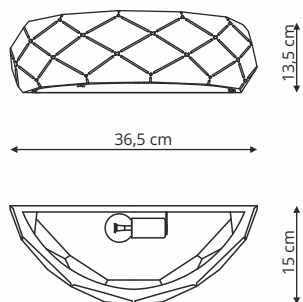



REUS

LP-8069/1WS biały LP-8069/1WS czarny

- sz. 14 x gł. 10 x wys. 15 cm
- metal
- 1 x E14, max 40W

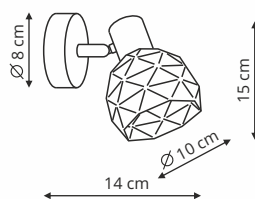

LP-8069/2WS biały LP-8069/2WS czarny

- sz. 30 x gł. 10 x wys. 17 cm
- metal
- 2 x E14, max 40W

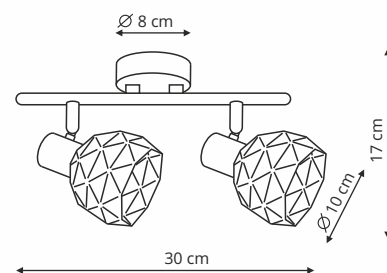



LP-8069/3WS biały

LP-8069/3WS czarny

 sz. 48 x gł. 10 x wys. 17 cm

 metal

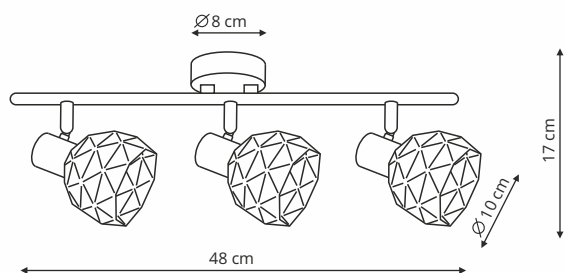

 3 x E14, max 40W

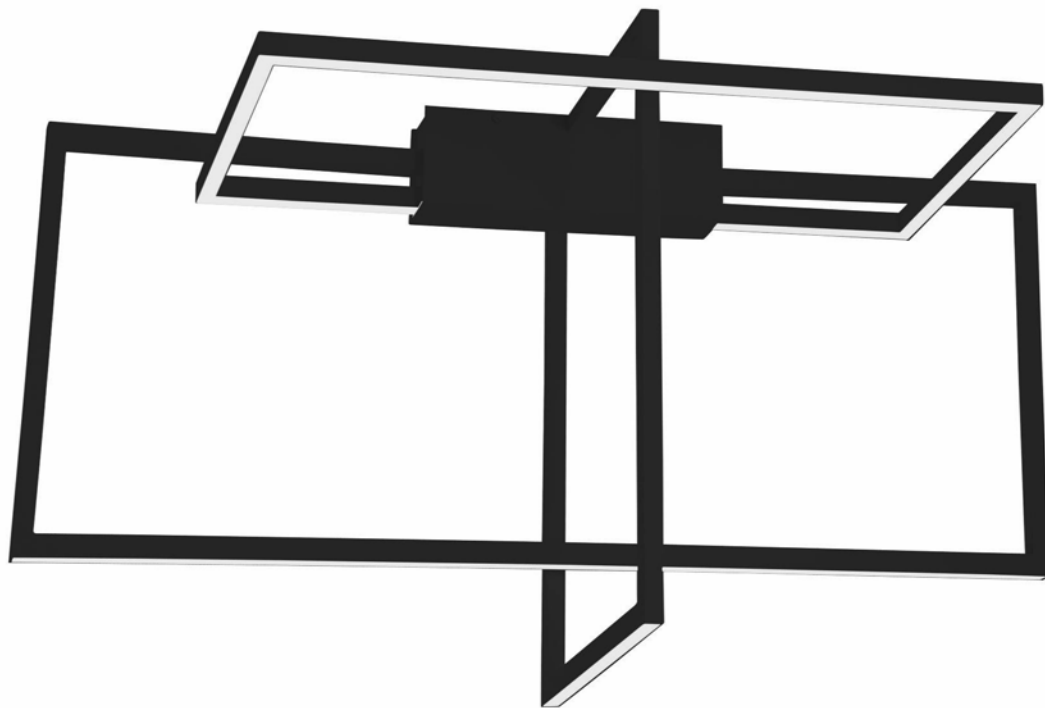



FRAME

LP-980/3D

-  sz. 92,6 x gł. 30,8 x wys. 52,8 cm
-  metal
-  3 x LED, 45W,
dostępne w barwie światła 3000K lub 4000K

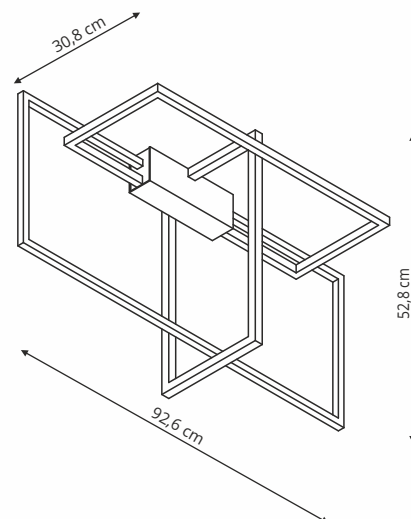



Czarny







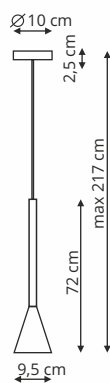

ARIZONA

LP-074/1P

-  sz. 9,5 x gł. 9,5 x wys. max 217 cm
-  metal
-  1 x GU10, max 50W



LP-074/4PL

-  sz. 117 x gł. 5,5 x wys. max 113,5 cm
-  metal
-  4 x GU10, max 50W

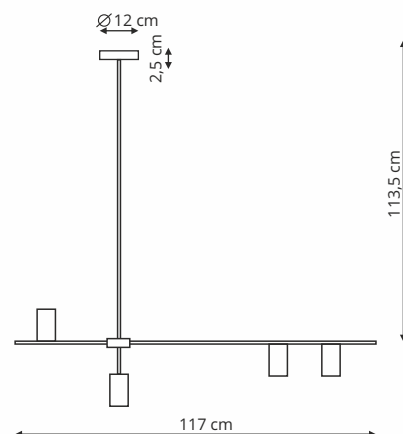

 Czarny / Złoty



LP-074/6PL

- ↗ sz. 117 x gł. 5,5 x wys. max 113,5 cm
- 🔧 metal
- 💡 6 x GU10, max 50W

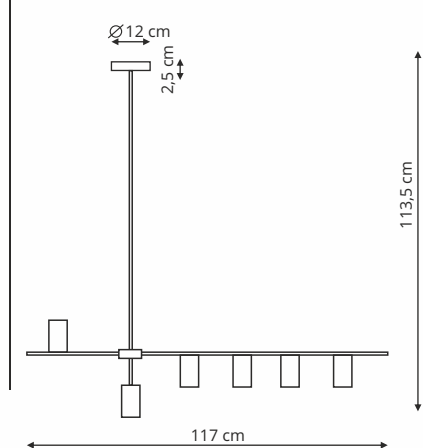

LP-074/9P

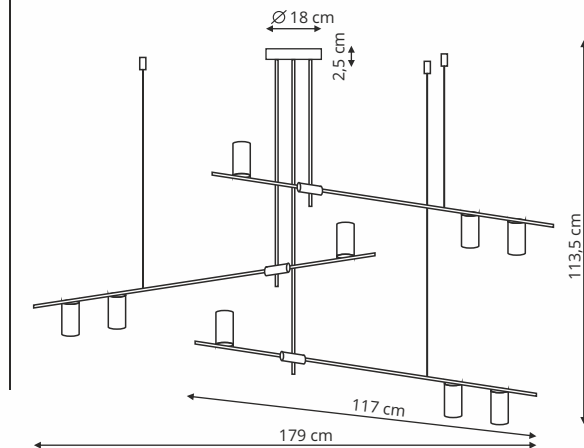

- ↗ sz. 179 x gł. 117 x wys. max 113,5 cm
- 🔧 metal
- 💡 9 x GU10, max 50W







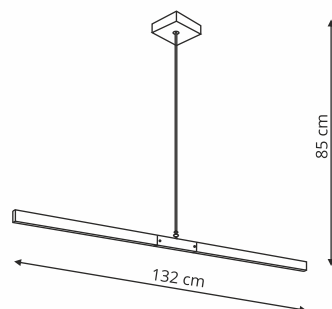

LUGANO

LP-2828/1P -132

-  sz. 132 x gł. 10 x wys. 85 cm
-  drewno, metal
-  1 x LED, 22W, 1360LM, 3000 K



LP-2828/3P

-  sz. 132 x wys. 53-100 cm
-  drewno, metal
-  3 x LED, 48W, 2800 LM, 3000 K

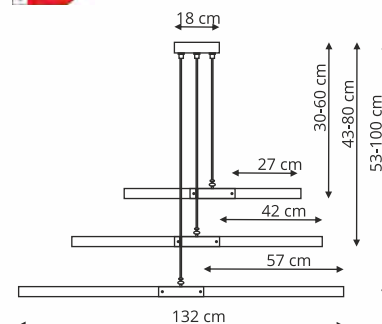

Czarny/ Brązowy





BURGO

LP-101335/1P S

- sz. 35 x gł. 35 x wys. 120 cm
- metal, naturalne drewno
- 1 x E27, max 60W

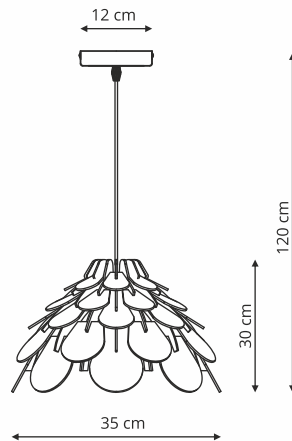

LP-101335/1P L

- sz. 50 x gł. 50 x wys. 120 cm
- metal, naturalne drewno
- 1 x E27, max 60W

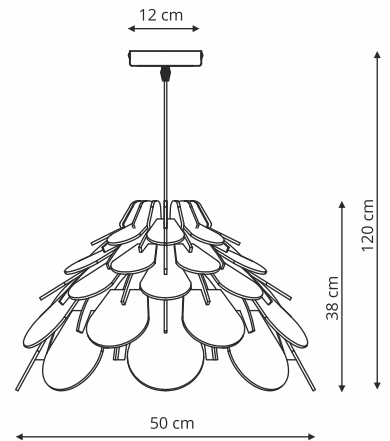

 Jasne drewno





BOVINO

LP-1111/1P

- sz. 12 x gł. 19 x wys. 43-80 cm
- metal, drewno
- 1 x GU10, LED max 5W

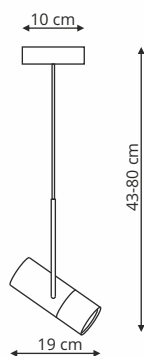

LP-1111/1W

- sz. 12 x gł. 19 x wys. 12 cm
- metal, drewno
- 1 x GU10, LED max 5W

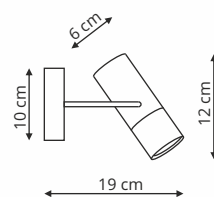

Czarny/ Brązowy





SOLIN

- Biały
- Szary
- Czarny

LP-181/1W biała
LP-181/1W szara
LP-181/1W czarna

- sz. 12 x gł. 12 x wys. 27 cm
- metal
- 1 x E14, max 40W

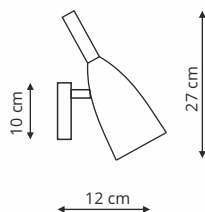

LP-181/1P biała
LP-181/1P szara
LP-181/1P czarna

- sz. 11 x gł. 11 x wys. 137,5 cm
- metal
- 1 x E27, max 60W

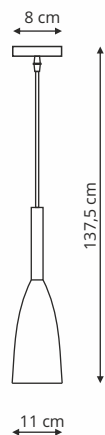



LP-181/3P biała
LP-181/3P szara
LP-181/3P czarna

🔧 sz. 30 x gł. 30 x wys. 100 cm

🔩 metal

💡 3 x E27, max 60W

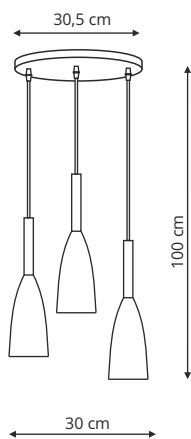

LP-181/3L biała
LP-181/3L szara
LP-181/3L czarna

🔧 sz. 15 x gł. 50 x wys. 100 cm

🔩 metal

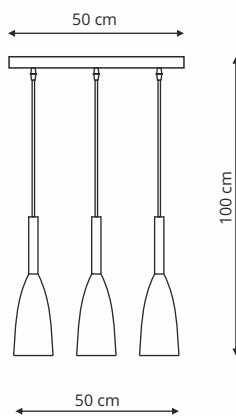

💡 3 x E27, max 60W







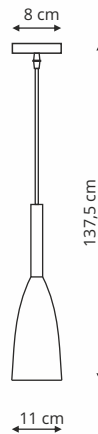

SOLIN

LP-181/1P czarno złota LP-181/1P złota

-  sz. 11 x gł. 11 x wys. 137,5 cm
-  metal
-  1 x E27, max 60W



LP-181/3P czarno złota LP-181/3P złota

-  sz. 30 x gł. 30 x wys. 100 cm
-  metal
-  3 x E27, max 60W

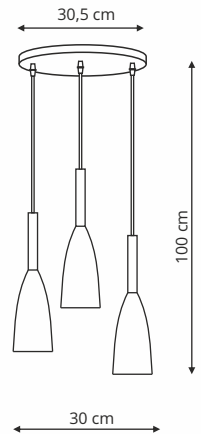



LP-181/3L czarno złota

LP-181/3L złota

🔧 sz. 15 x gł. 50 x wys. 100 cm

🔩 metal

💡 3 x E27, max 60W

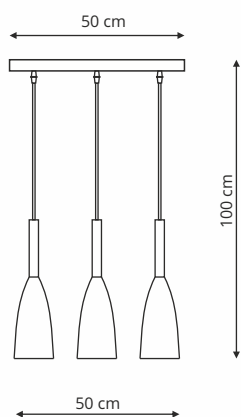



CANARIA

LP-6704/5P

sz. 58 x gł. 58 x wys. 127 cm

metal

5 x E27, max 60W

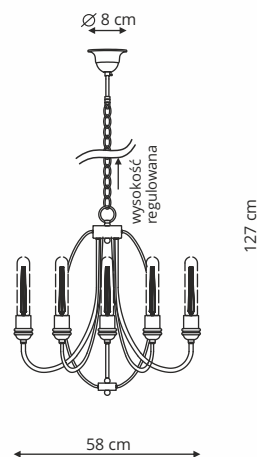

 Czarny



TARRAGONA

LP-6756/6P

- sz. 61 x gł. 61 x wys. 126 cm
- metal
- 6 x E14, max 40W

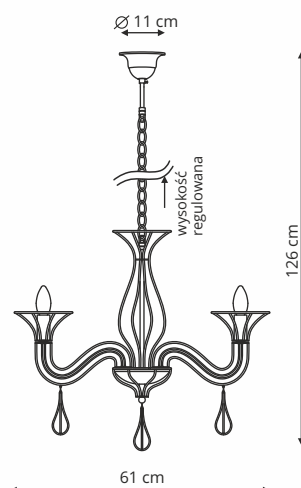



Czarny





SADA

LP-119/3C

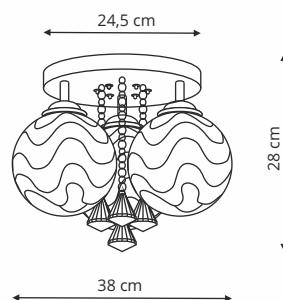
-  sz. 38 x gł. 38 x wys. 28 cm
-  metal, akryl
-  3 x E14, max 60W, 6 x LED, 0.06W



LP-119/3C

-  sz. 40 x gł. 40 x wys. 38 cm
-  metal, akryl
-  5 x E14, max 40W, 18 x LED, 0.06W

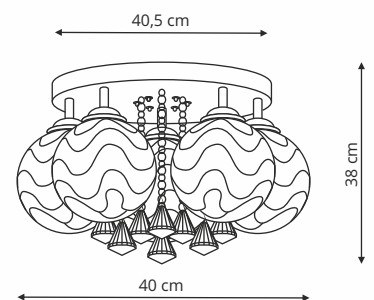



 Chrom / Biały







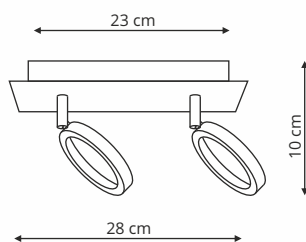

CARRARA

LP-1864/2W

-  sz. 28 x gł. 8 x wys. 10 cm
-  metal, kryształ
-  2 x LED, 5W, 3000K, 650 LM



LP-1864/4C

-  sz. 25 x gł. 25 x wys. 18 cm
-  metal, kryształ
-  4 x LED, 5W, 3000K, 1300 LM

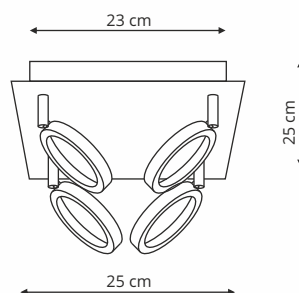



 Chrom



MONTANA

LP-2210/1C-25 dymna

-  sz. 25 x gł. 25 x wys. 12,5 cm
-  akryl, metal
-  1 x LED 12W, 4000K



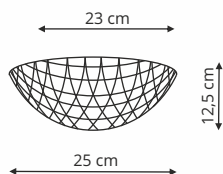

Produkt posiada certyfikat



 Transparentny

MONZA

LP-2323/2C

-  sz. 30 x gł. 30 x wys. 12 cm
-  szkło, metal
-  2 x E14, max 60W

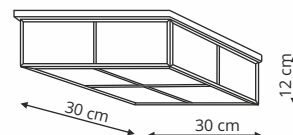



 Chrom



KONSTELACJA

LP-055/1P

-  sz. 35 x gł. 35 x wys. max 160 cm
-  szkło, metal
-  7 x G9, max 5W LED

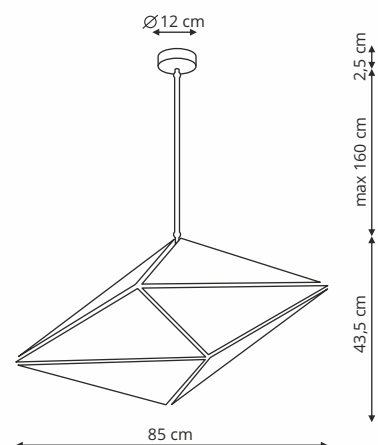

Czarny



LP-056/1P

 sz. 35 x gł. 35 x wys. max 160 cm

 szkło, metal

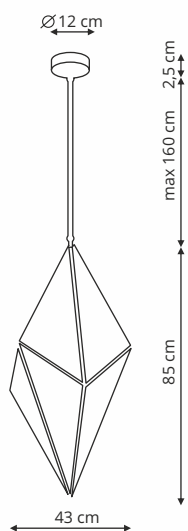

 7 x G9, max 5W LED







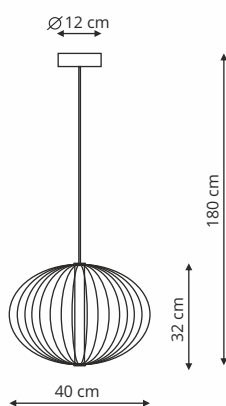

TREVISO

LP-798/1P S mała czarna

-  sz. 40 x gł. 40 x wys. 180 cm
-  metal
-  1 x LED 18W, 3000K, 1600LM



LP-798/1P L duża złota

-  sz. 60 x gł. 60 x wys. 180 cm
-  metal
-  1 x LED, 28W, 3000K, 2400LM

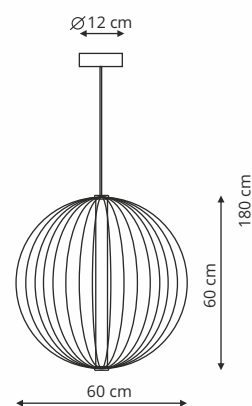







GALAXY

LP-8527/4P

-  sz. 85 x gł. 28 x wys. 93 cm
-  szkło, metal
-  5 x E27, max 40W

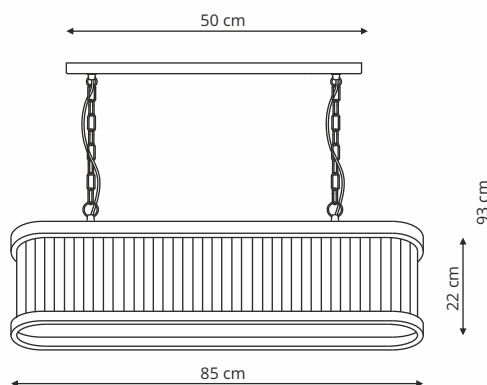



Czarny







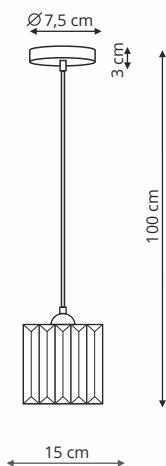

GALACTICO

LP-2383/1P

-  sz. 15 x gł. 15 x wys. 100 cm
-  szkło, metal
-  1 x E27, max 60W



LP-2383/3L

-  sz. 15 x gł. 50 x wys. 100 cm
-  szkło, metal
-  3 x E27, max 60W

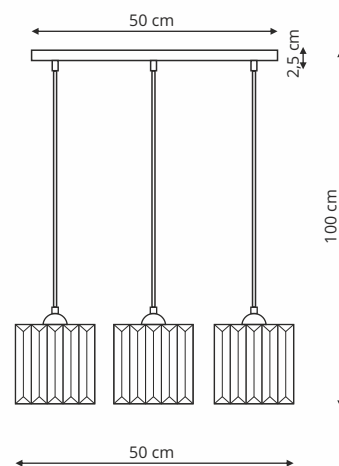

Czarny



LP-2383/3P

✂ sz. 30 x gł. 30 x wys. 100 cm

🔍 szkło, metal

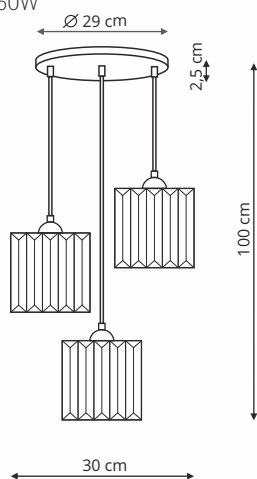

💡 3 x E27, max 60W







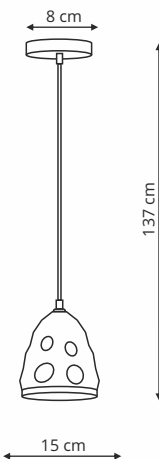

MELT

LP-126/1P

-  sz. 15 x gł. 15 x wys. 137 cm
-  szkło, metal
-  1 x E27, max 40W



LP-126/3L

-  sz. 30 x gł. 61 x wys. 137 cm
-  szkło, metal
-  3 x E27, max 40W

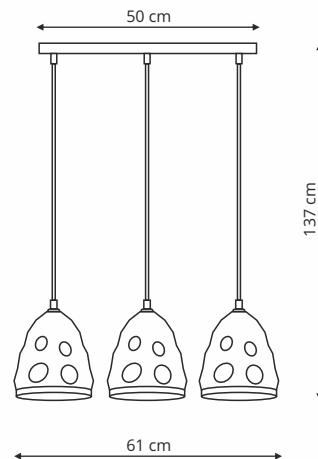

 Dymny





FONDI

LP-1214/1W

- sz. 19 x gł. 19 x wys. 36 cm
- szkło, metal
- 1 x E14, max 40W

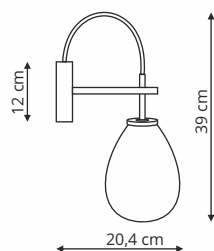

LP-1214/1P

- sz. 16 x gł. 16 x wys. 130 cm
- szkło, metal
- 1 x E14, max 40W

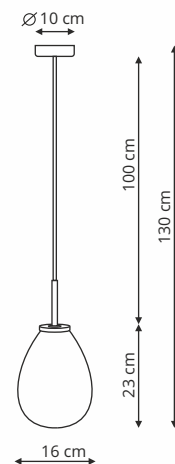

 Transparentny



LP-1214/3P

sz. 35 x gł. 35 x wys. 130 cm

szkło, metal

3 x E14, max 40W

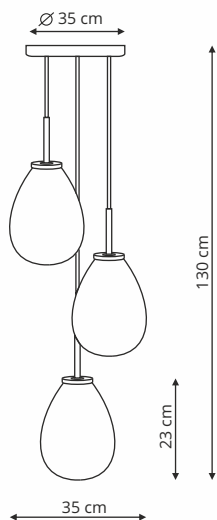

LP-1214/3L

sz. 15 x gł. 64 x wys. 130 cm

szkło, metal

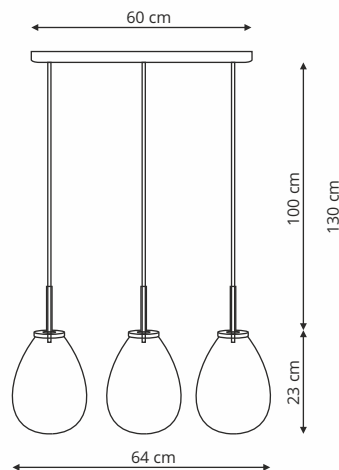

3 x E14, max 40W







NIKI

LP-567/1P transparentna
LP-567/1P dymna

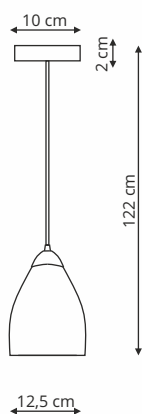
-  sz. 12,5 x gł. 12,5 x wys. 122 cm
-  szkło, metal
-  1 x E14, max 40W





-  Transparentny
-  Dymny







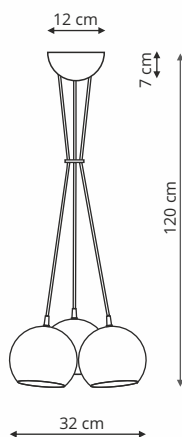

RAME

LP-2014/3P

-  sz. 32 x gł. 39 x wys. 120 cm
-  metal
-  3 x E14, max 40W



LP-2014/1W

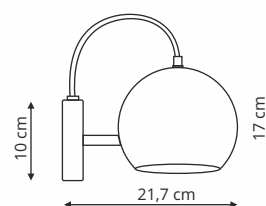

-  sz. 14 x gł. 21,7 x wys. 17 cm
-  metal
-  1 x E14, max 40W



 Miedziany



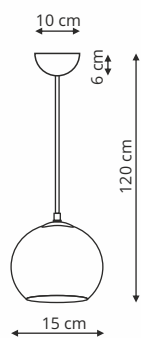

LP-2014/1P mała

-  sz. 15 x gł. 15 x wys. 120 cm
-  metal
-  1 x E14, max 40W



LP-2014/1P duża

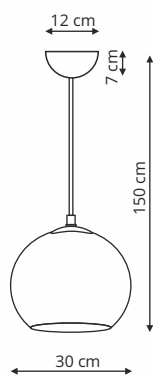

-  sz. 30 x gł. 30 x wys. 150 cm
-  metal
-  1 x E27, max 40W







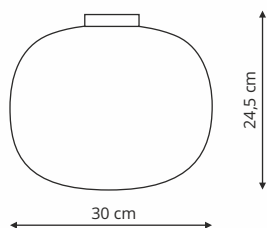

JUKON

LP-052/1C

-  sz. 30 x gł. 30 x wys. 24,5 cm
-  szkło, metal
-  1 x E27, max 60W



LP-052/1P

-  sz. 30 x gł. 30 x wys. 150 cm
-  szkło, metal
-  1 x E27, max 60W

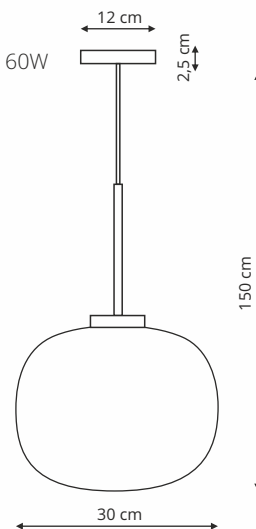

 Biały





ESTRELLA

LP-075/6P

- sz. 48 x gł. 110 x wys. 127 cm
- metal
- 6 x E27, max 40W

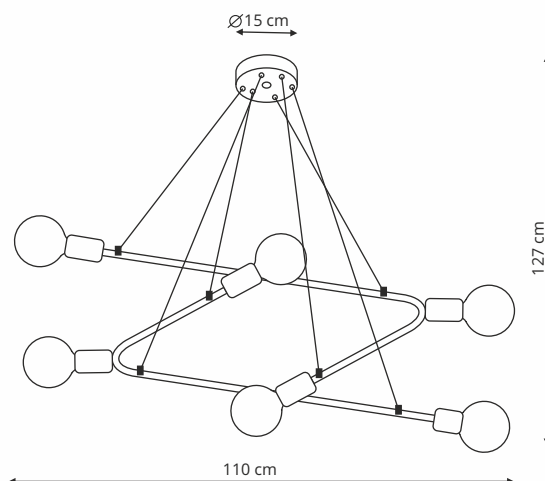



Czarny







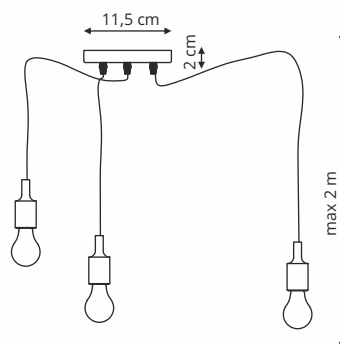

SOLETO

LP-90082/3P

-  długość każdego kabla 2m
-  silikon
-  3 x E27, max 60W



LP-90082/5P

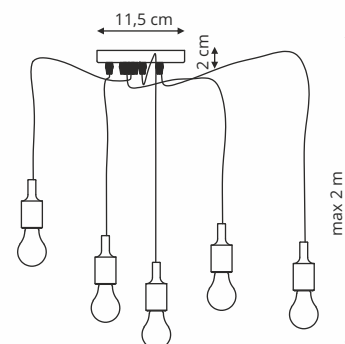

-  długość każdego kabla 2m
-  silikon
-  5 x E27, max 60W



Czarny



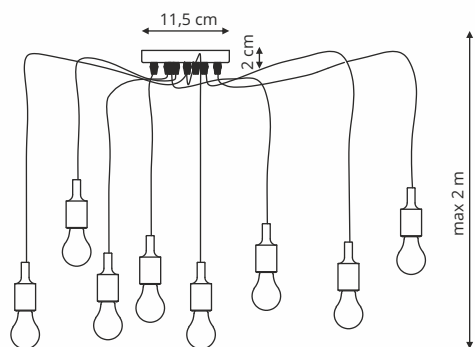

LP-90082/7P

-  długość każdego kabla 2m
-  silikon
-  7 x E27, max 60W



LP-90082/10P

-  długość każdego kabla 2m
-  silikon
-  10 x E27, max 60W

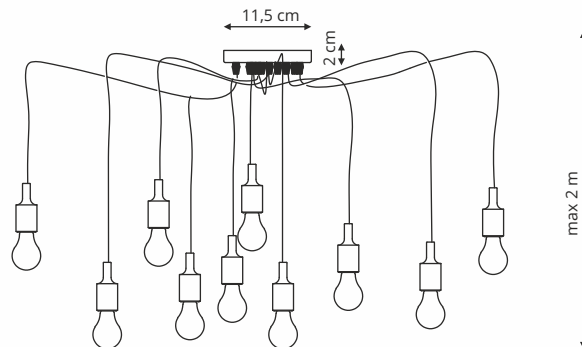



NAPOLI

LP-4146/1P czarna

sz. 18,5 x gł. 18,5 x wys. 144,5 cm

metal

1 x E27, max 60W

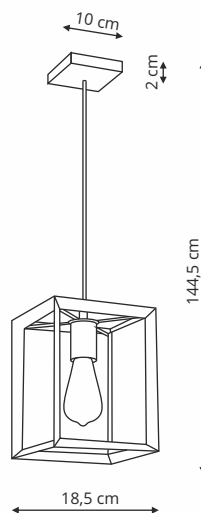



Czarny





NOLA

LP-076/1P

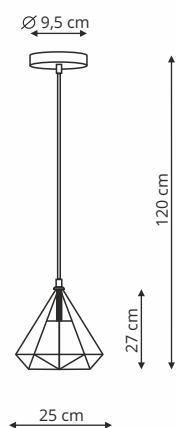
-  sz. 25 x gł. 25 x wys. 120 cm
-  metal, tkanina
-  1 x E27, max 60W



LP-076/3P

-  sz. 35 x gł. 35 x wys. 70 cm
-  metal, tkanina
-  3 x E27, max 60W

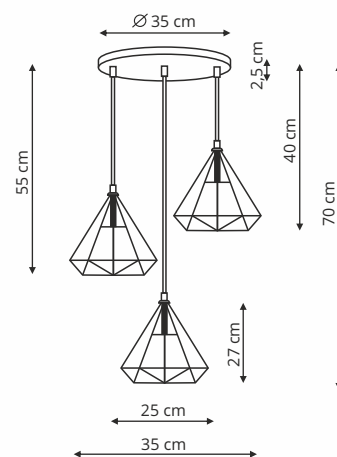

 Czarny



DRITTO

LP-123/1P S

sz. 25 x gł. 25 x wys. 126 cm

metal

1 x E27, max 60W

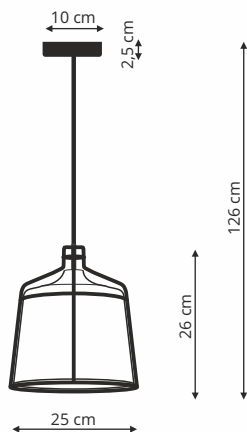

LP-123/1P M

sz. 31,5 x gł. 31,5 x wys. 124 cm

metal

1 x E27, max 60W

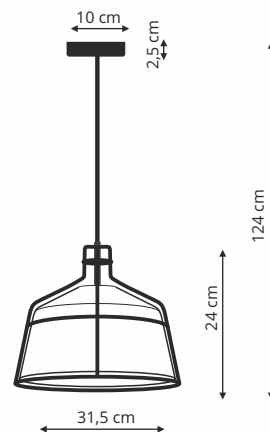

Biały / Czarny







JET

LP-023/1P wisząca złota

LP-023/1P wisząca biała

-  sz. 45 x gł. 45 x wys. 100 cm
-  plastik, metal
-  1 x E27, max 60W

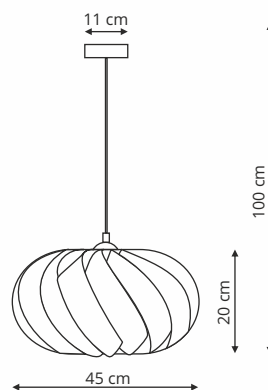







DELOS

LP-8144/1P biała

LP-8144/1P czarna

-  sz. 40 x gł. 40 x wys. 120 cm
-  tkanina, metal, akryl
-  2 x E27, max 60W

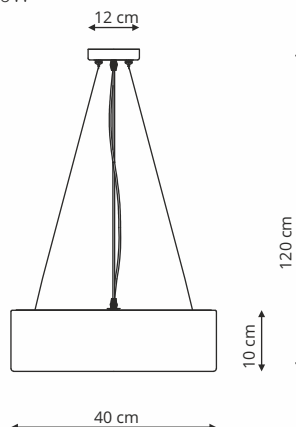



MADRYT

LP-81458/1P biała

LP-81458/1P czarna

✂ sz. 40 x gł. 40 x wys. 120 cm

📏 tkanina, metal, kryształ

💡 1 x E27, max 60W

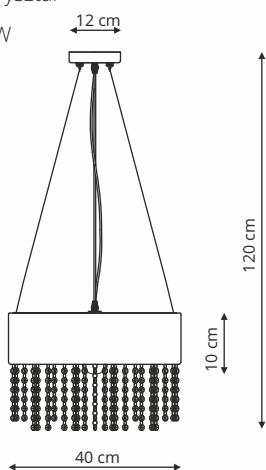

- Biały
- Czarny





MALAGA

LP-622/1P biała

LP-622/1P szara

LP-622/1P czarna

-  sz. 45 x gł. 45 x wys. 120 cm
-  metal, akryl
-  1 x LED 24W, 1700 LM, 3000 K

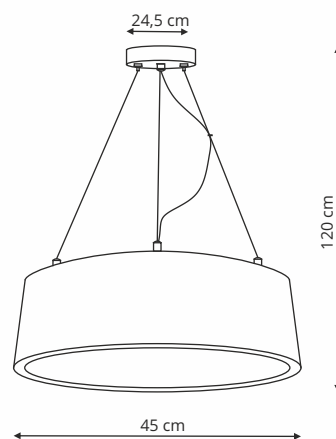









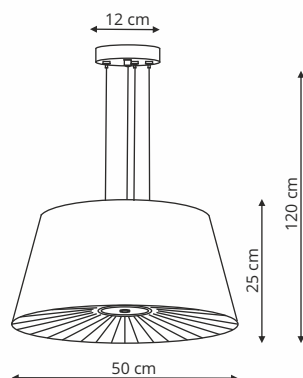

BALI

LP-1322/1P biała
LP-1322/1P czarna

-  sz. 50 x gł. 50 x wys. 120 cm
-  metal, tkanina
-  4 x E27, max 60W



LP-5031/1W biała
LP-5031/1W czarna

-  sz. 21 x gł. 17 x wys. 23 cm
-  metal, tkanina
-  1 x E14, max 40W

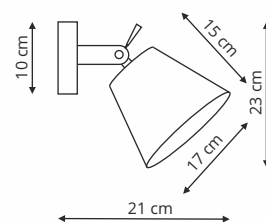









MILK

LP-021/4P biały

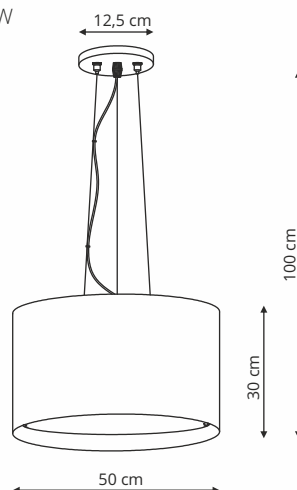
-  sz. 50 x gł. 50 x wys. 100 cm
-  tkanina, metal
-  4 x E27 max 60W



 Kremowy





SUNFLOWER

LP-818/1T biała
LP-818/1T czarna

- ↙ sz. 28 x gł. 28 x wys. 51,6 cm
- 👁️ szkło, tkanina
- 💡 1 x E27, max 40W

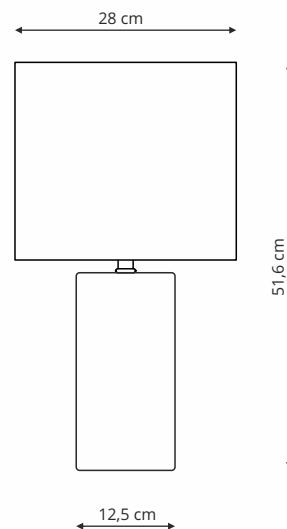





ALTO

LP-81008/3C czarna

LP-81008/3C biała

LP-81008/3C szara

 sz. 40 x gł. 40 x wys. 10 cm

 tkanina, akryl

 3 x E14, max 40W

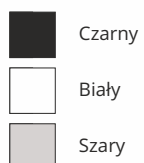
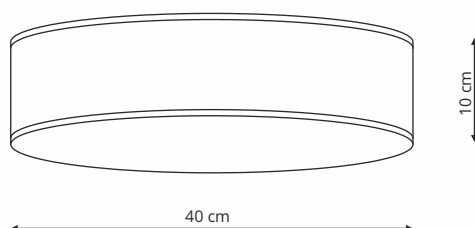





HUDSON

LP-043/1P biało / złota

LP-043/1P czarno / złota

↗ sz. 40 x gł. 40 x wys. 120 cm

🔧 metal, akryl

💡 1 x LED, 34W, 1900 LM, 3000 K

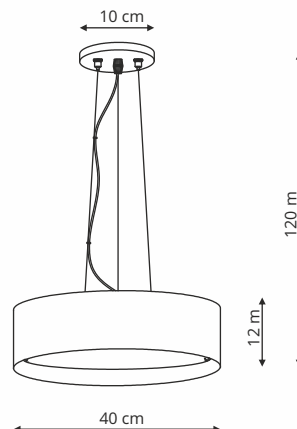



LP-043/1C biała

LP-043/1C czarna

 sz. 35 x gł. 35 x wys. 12 cm

 metal, akryl

 1 x LED, 24W, 1350 LM, 3000 K

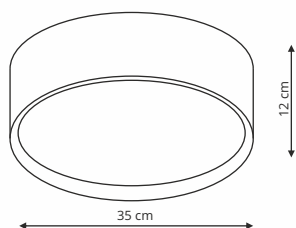



MARBELLA

LP-332/1F

- sz. 36 x gł. 36 x wys. 155 cm
- metal, tkanina
- 1 x E27, max 60W

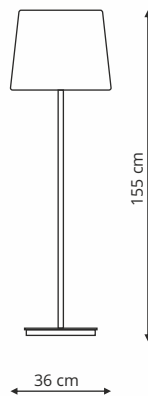

LP-332/1T

- sz. 26 x gł. 26 x wys. 46 cm
- metal, tkanina
- 1 x E27, max 60W

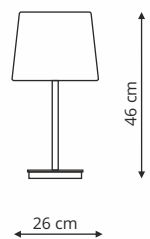

 Czarny



LP-332/1W

- sz. 22 x gł. 18 x wys. 30 cm
- metal, tkanina
- 1 x E14, max 60W
- 1 x LED 3W

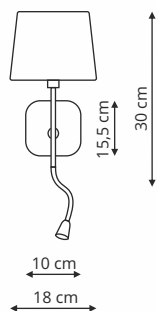



TAMIZA

LP-1515/1T L

- sz. 41 x gł. 41 x wys. 65 cm
- metal, tkanina
- 1 x E27, max 40W

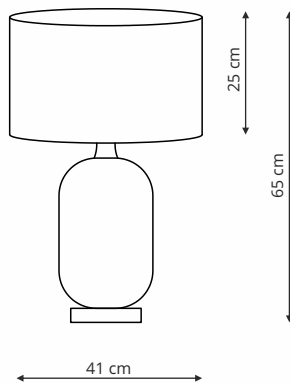

LP-1515/1T S

- sz. 33 x gł. 33 x wys. 148 cm
- metal, tkanina
- 1 x E27, max 40W

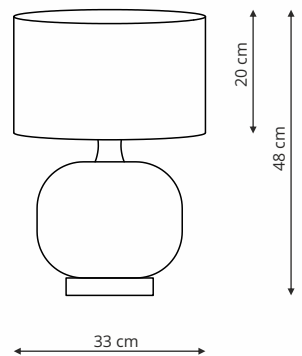

 Czarny / Złoty





CECINA

LP-114/1W biała

LP-114/1W czarna

 sz. 18 x gł. 15 x wys. 25 cm

 metal, tkanina

 1 x E14, max 40W

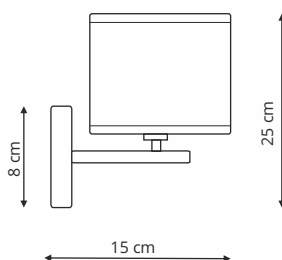





DAKOTA



Posiada gniazdo USB



LP-2121/1W prawa biała
LP-2121/1W lewa biała
LP-2121/1W prawa czarna
LP-2121/1W lewa czarna

-  sz. 25 x gł. 23 x wys. 38,5 cm
-  metal, tkanina, silikon
-  1 x E27 max 60W
1 x LED 3W

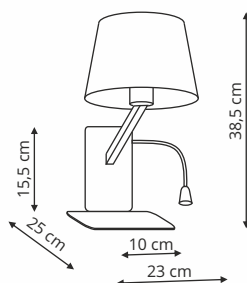



CASOLI

LP-2118/1W chrom

LP-2118/1W patyna

✂ sz. 12,8x gł. 14,8 x wys. 43 cm

🔧 metal, tkanina

💡 1 x E14, max 40W

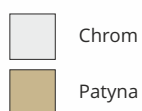
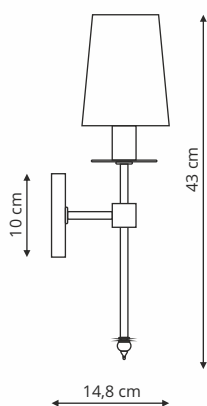



TIVOLI

LP-1133/1W biała

LP-1133/1W chrom

LP-1133/1W czarna

 sz. 15 x gł. 18 x wys. 30 cm

 metal, tkanina

 1 x E27, max 40W

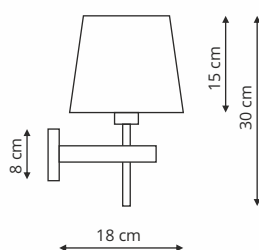

-  Biały
-  Chrom
-  Czarny



SENISE

LP-2021/1W biała

LP-2021/1W czarna

sz. 10,5 x gł. 10,5 x wys. 50 cm

metal

1 x LED 3W, 132 LM, 3000 K

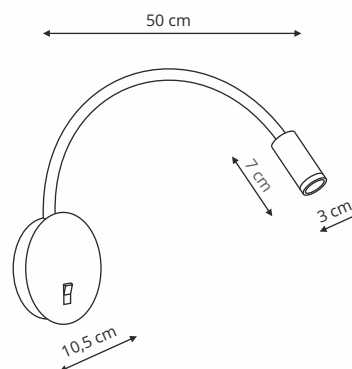



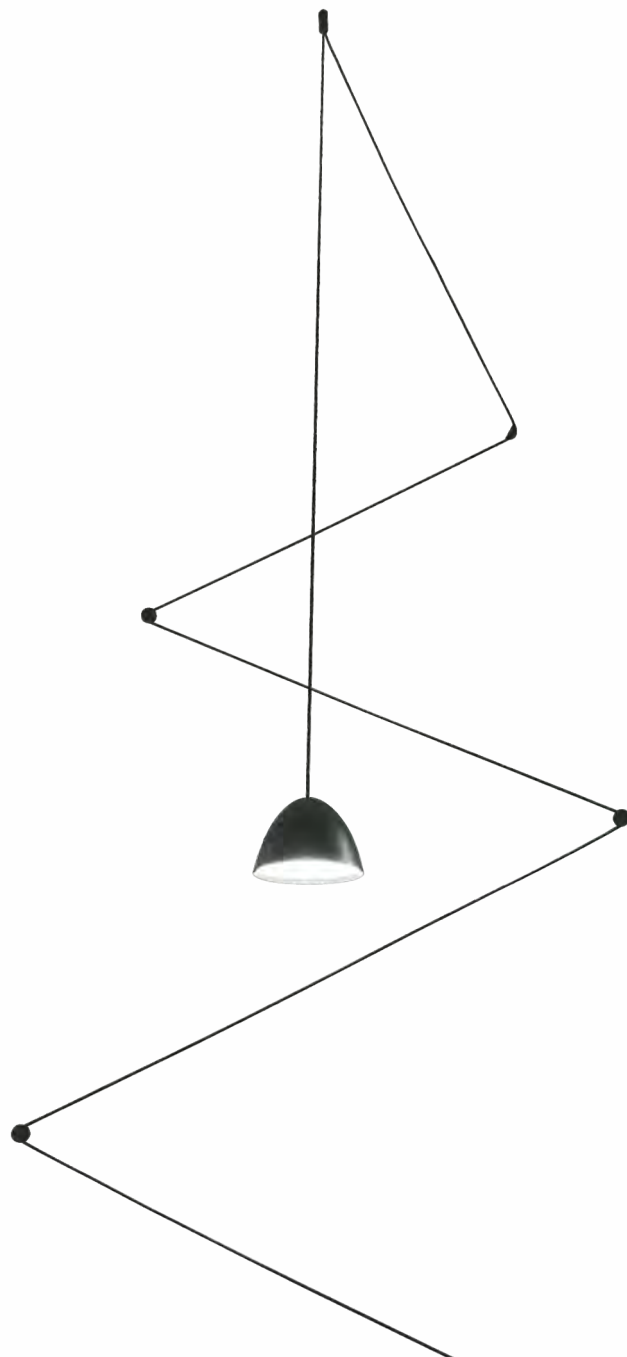

ZIG-ZAG

LP-1243/1P czarna

- średnica klosza 12 cm x długość przewodu (ok. 11,8 m)
 - uchwyty do ściany w komplecie: 5 ściennych, 1 sufitowy
 - metal, akryl
 - 1 x LED, max 7W, 402 LM, 3000 K
- Oprawa ma możliwość podpięcia do puszk
lub do kontaktu (posiada wtyczkę w komplecie).

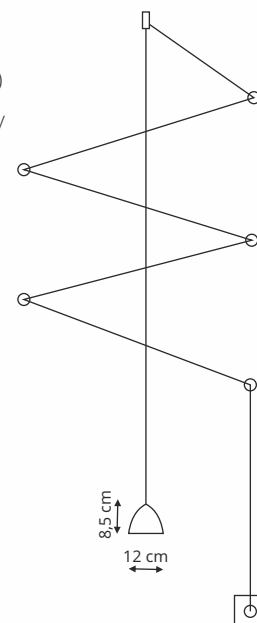



Czarny







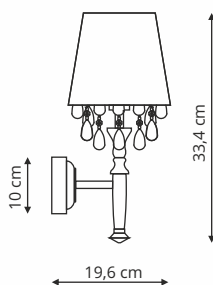

VIGO

LP-0412/1W biała
LP-0412/1W czarna

-  sz. 17 x gł. 19,6 x wys. 33,4 cm
-  tkanina, metal, kryształ
-  1 x E14, max 40W



LP-0412/1P biała
LP-0412/1P czarna

-  sz. 40 x gł. 40 x wys. 120 cm
-  tkanina, metal, kryształ
-  2 x E27, max 60W

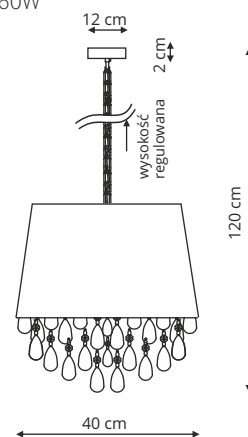



-  Biały / Srebrny
-  Czarny / Złoty







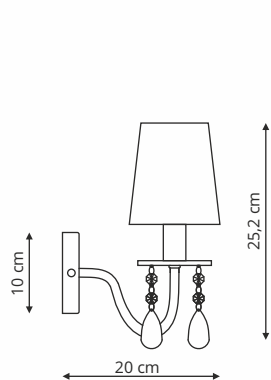

MONA

LP-5005/1W czarna
LP-5005/1W srebrna

-  sz. 20 x gł. 12 x wys. 25,2 cm
-  metal, materiał, kryształ
-  1 x E14, max 40W



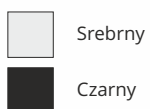
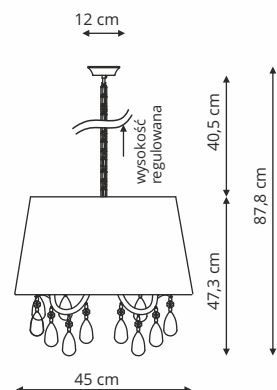

LP-5005/5P czarna
LP-5005/5P srebrna

-  sz. 45 x gł. 45 x wys. 87,8 cm
-  metal, materiał, kryształ
-  5 x E14, max 40W





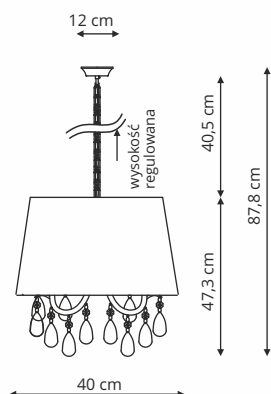

LP-5005/3P czarna
LP-5005/3P srebrna

-  sz. 40 x gł. 40 x wys. 87,8 cm
-  metal, materiał, kryształ
-  3 x E14, max 40W



LP-5005/1TS czarna
LP-5005/1TS srebrna

-  sz. 23 x gł. 23 x wys. 42,5 cm
-  metal, materiał, kryształ
-  1 x E27, max 60W

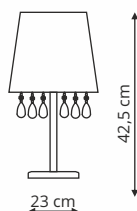



VETRO

LP-2910/1T chrom

- sz. 25 x gł. 25 x wys. 40 cm
- szkło, metal
- 1 x E14, max 40W

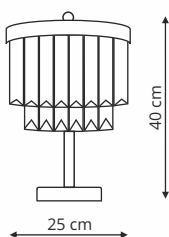

LP-2910/1W chrom

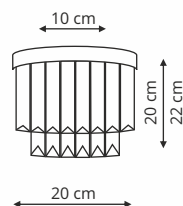

- sz. 20 x gł. 10,5 x wys. 22 cm
- szkło, metal
- 1 x E14, max 40W



 Chrom



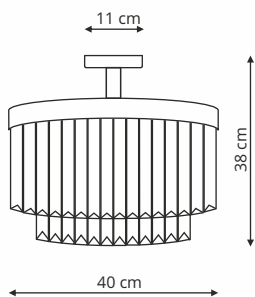

LP-2910/4C chrom

-  sz. 40 x gł. 40 x wys. 38 cm
-  szkło, metal
-  4 x E14, max 40W



LP-2910/5P chrom

-  sz. 45 x gł. 45 x wys. 120 cm
-  szkło, metal
-  5 x E14, max 60W

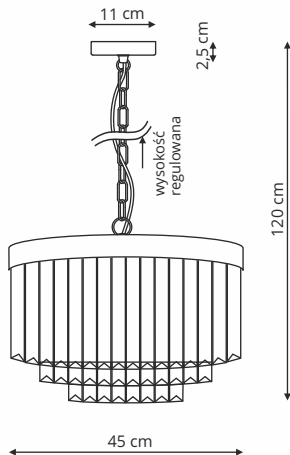



VETRO

LP-2910/4P złota

- ↗ sz. 40 x gł. 40 x wys. 120 cm
- 👉 szkło, metal
- 💡 4 x E14, max 40W

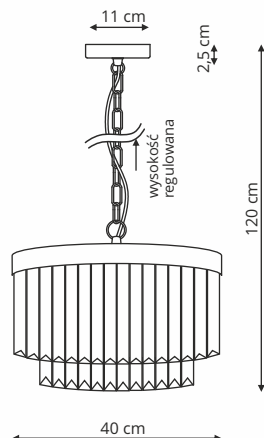

LP-2910/5P złota

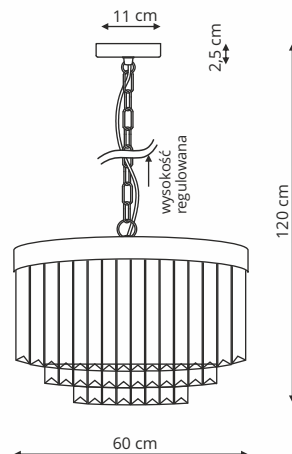

- ↗ sz. 60 x gł. 60 x wys. 120 cm
- 👉 szkło, metal
- 💡 5 x E14, max 60W



 Złoto



LP-2910/1W złota

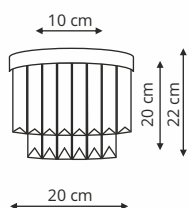

-  sz. 20 x gł. 10,5 x wys. 22 cm
-  szkło, metal
-  1 x E14, max 40W







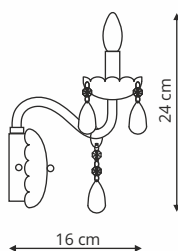

CRISTALLO

LP-2940/1W

-  sz. 16 x gł. 12 x wys. 24 cm
-  szkło, metal
-  1 x E14, max 60W



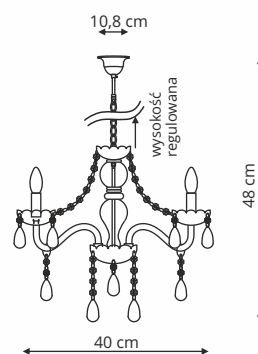

LP-2940/3P

-  sz. 40 x gł. 40 x wys. 48 cm
-  szkło, metal
-  3 x E14, max 60W





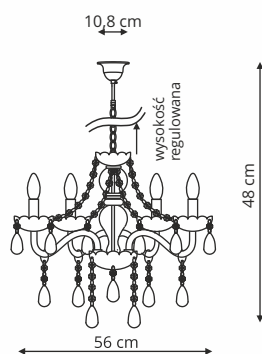

LP-2940/5P

-  sz. 56 x gł. 56 x wys. 48 cm
-  szkło, metal
-  5 x E14, max 60W



LP-2940/8P

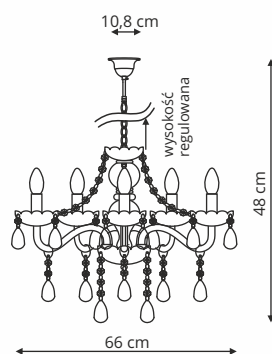

-  sz. 66 x gł. 66 x wys. 48 cm
-  szkło, metal
-  8 x E14, max 60W







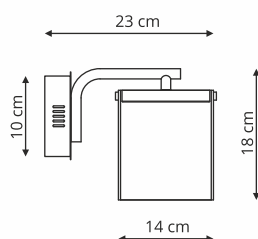

CANTOS

LP-1114/1W

-  sz. 14 x gł. 23 x wys. 18 cm
-  metal, kryształ, szkło
-  1 x LED, 6W, 480 LM, 4000 K



LP1114/1P

-  sz. 13 x gł. 13 x wys. 120 cm
-  metal, kryształ, szkło
-  1 x LED, 6W, 480 LM, 4000 K

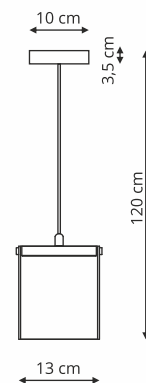

 Transparentny / Chrom



LP-1114/3C

- ✂ sz. 28 x gł. 28 x wys. 104 cm
- 🔧 metal, kryształ, szkło
- 💡 3 x LED, 6W, 1440 LM, 4000 K

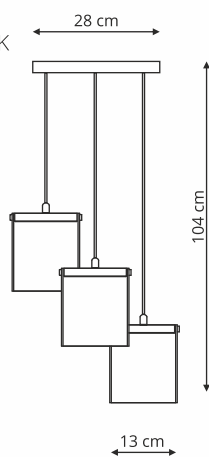



GRAFFITI

LP-077/1P

- sz. 40 x gł. 40 x wys. 100 cm
- plastik, metal
- 1 x E27, max 60W

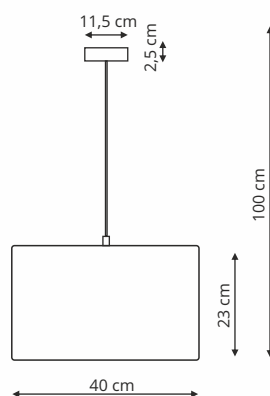



Wielokolorowy





RUBI

LP-044/1P Biała

-  sz. 13 x gł. 13 x wys. 100 cm
-  akryl
-  1 x E27, max 60W

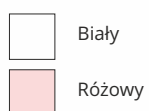
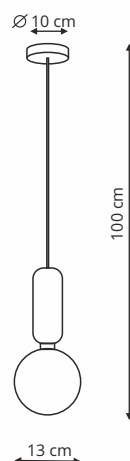



LP-044/3P Pink

✂ sz. 25 x gł. 25 x wys. 100 cm

👁️ akryl

💡 3 x E27, max 60W

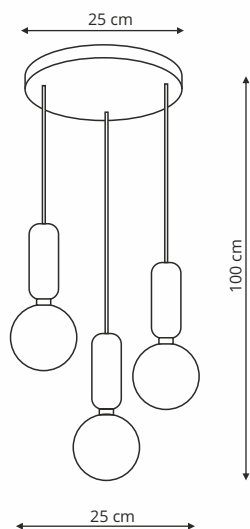



BUTTERFLY

LP-PD024

- sz. 32 x gł. 32 x wys. 100 cm
- tkanina, metal
- 1 x E27, max 60W

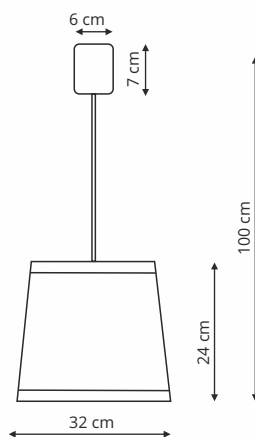



 Różowy





FLOWERS

LP-686/1P biała
LP-686/1P różowa

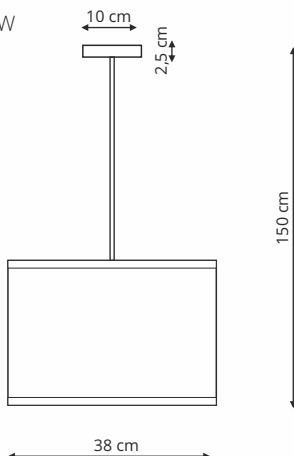
-  sz. 38 x gł. 38 x wys. 150 cm
-  tkanina, plastik
-  1 x E27, max 40W



-  Biały
-  Różowy





FARFALLA



LP-3439/1P biała

LP-3439/1P ciemno różowa

LP-MD088-3439A/1P różowa

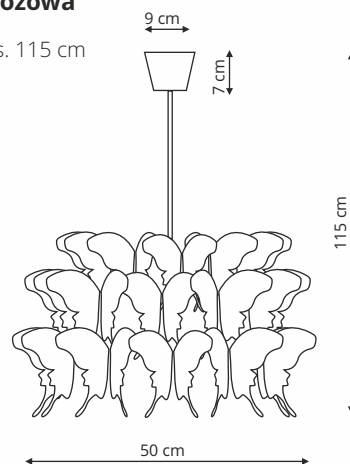
-  sz. 50 x gł. 50 x wys. 115 cm
-  akryl, metal
-  1 x E27, max 60W



-  Ciemny różowy
-  Jasny różowy
-  Biały





FUTURO

LP-17001/1W biała
LP-17001/1W złota
LP-17001/1W czarna

sz. 9 x gł. 20 x wys. 20,5 cm

metal

1 x GU10, max 35W

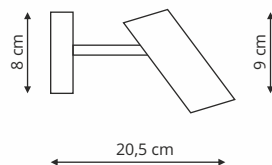

LP-17001/1WL biała
LP-17001/1WL złota
LP-17001/1WL czarna

sz. 9 x gł. 41 x wys. 38,5 cm

metal

1 x GU10, max 35W

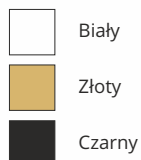
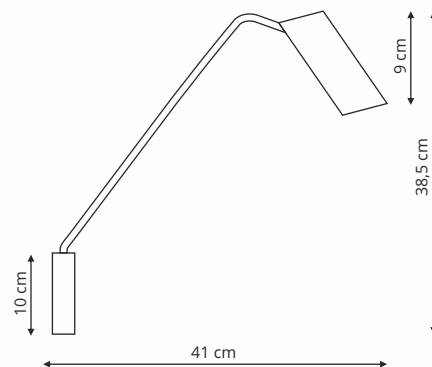



LP-17001/3C biała

LP-17001/3C czarna

 sz. 73 x gł. 73 x wys. 36,8 cm

 metal

 3 x GU10, max 35W

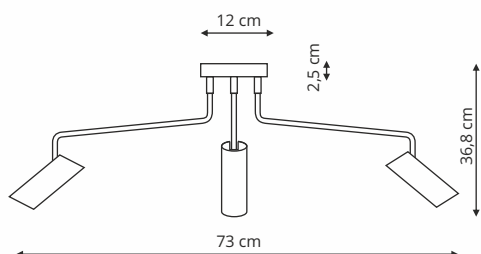



ASTAMA

LP-1122/1W biała

LP-1122/1W złota

LP-1122/1W czarna

 sz. 13,6 x gł. 16,6 x wys. 16,8 cm

 metal

 1 x E14, max 40W

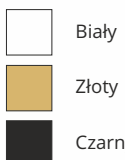
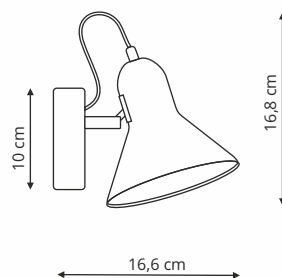



AREZZO

LP-1420/1W biała

LP-1420/1W czarna

 sz. 14,5 x gł. 10 x wys. 10 cm

 metal

 1 x E14, max 40W

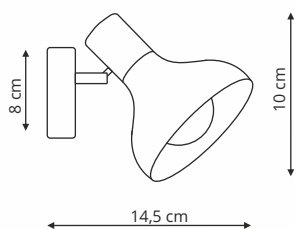

 Biały

 Czarny



OREGON

LP-106/1W biała
LP-106/1W czarna
LP-106/1W czarno złota

 sz. 8 x gł. 10 x wys. 11 cm

 metal

 1 x G9

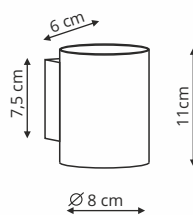

 Biały

 Czarny

 Czarny / Złoty



ALASKA

LP-104/1W biała

LP-104/1W czarna

 sz. 10 x gł. 12 x wys. 10 cm

 metal

 1 x G9

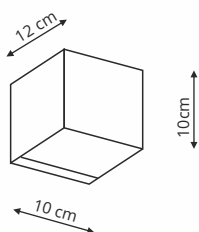



 Biały

 Czarny



TORINO

LP-109/1W czarna LP-109/1W antracyt

-  sz. 6 x gł. 10 x wys. 16,5 cm
-  metal
-  2 x GU10, max 40W

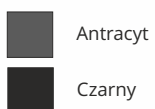
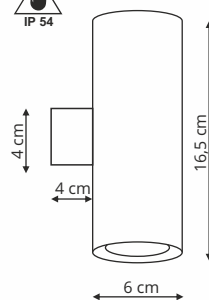

Produkt posiada certyfikat





SAPRI

LP-1556/1W biała
LP-1556/1W antracyt
LP-1556/1W czarna

-  sz. 10 x gł. 13 x wys. 3,5 cm
-  metal
-  LED 2 x 3W, 400LM, 4000K



Produkt posiada certyfikat

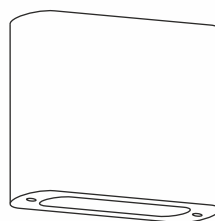

-  Biały
-  Antracyt
-  Czarny



GEORGIA

LP-049/1C biała

LP-049/1C złota

LP-049/1C czarna

 sz. 60 x gł. 60 x wys. 11 cm

 metal, akryl

 1 x LED, 36W, 3600 LM, 3000 K

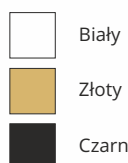

Biały

Złoty

Czarny

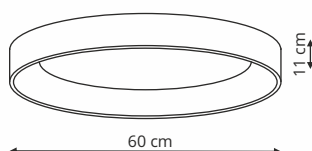





RAPIDO

LP-433/1C S plafon LED mały biały LP-433/1C S plafon LED mały czarny

- sz. 30 x gł. 630 x wys. 5 cm
- metal, akryl
- 1 x LED 24W, 1344 LM, 4000K

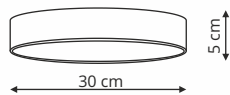

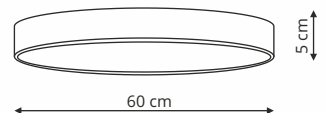

LP-433/1C L plafon LED duży biały LP-433/1C L plafon LED duży czarny

- sz. 60 x gł. 60 x wys. 5 cm
- metal, akryl
- 1 x LED 45W, 2520 LM, 4000K





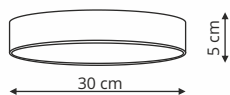

LP-433/1C 3S plafon LED mały biały
LP-433/1C 3S plafon LED mały czarny

-  sz. 30 x gł. 630 x wys. 5 cm
-  metal, akryl
-  1 x LED 24W, 1344 LM, 3000K



LP-433/1C 3L plafon LED duży biały
LP-433/1C 3L plafon LED duży czarny

-  sz. 60 x gł. 60 x wys. 5 cm
-  metal, akryl
-  1 x LED 45W, 2520 LM, 3000K

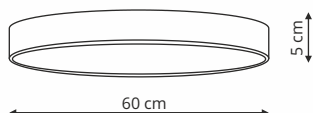



LORIA

Oprawa natynkowa LP-2526/1C-30 biała

- sz. 30 x gł. 30 x wys. 2,4 cm
- metal, akryl
- 1 x LED, 26W, 1820 LM, 3000 K

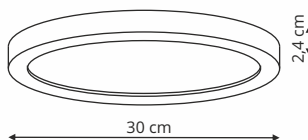

Oprawa natynkowa LP-2526/1C-40 biała

- sz. 40 x gł. 40 x wys. 3,8 cm
- metal, akryl
- 1 x LED, 32W, 2100 LM, 3000 K

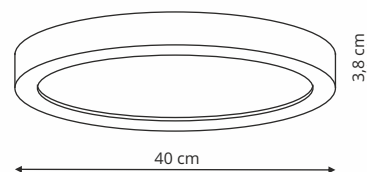



Biały



YORK



podtynkowy | natynkowy

LP-330/1C 3 biała LP-330/1C 3 czarna

-  sz. 33 x gł. 33 x wys. 1,9 cm
-  metal, akryl
-  1 x LED, 24W, 1900 LM, 3000K, ką t Se120 stopni, CRI80



LP-330/1C 4 biała LP-330/1C 4 czarna

-  sz. 33 x gł. 33 x wys. 1,9 cm
-  metal, akryl
-  1 x LED, 24W, 1900 LM, 4000K, ką t Se120 stopni, CRI80



Możliwy montaż:
podtynkowy

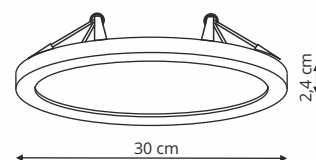

natynkowy

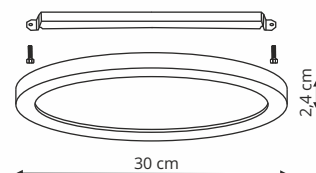



SNOW

LP-731/6P biała

LP-731/6P złota

LP-731/6P czarna

✂ sz. 80 x gł. 12 x wys. 44,5 cm

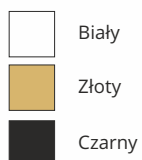
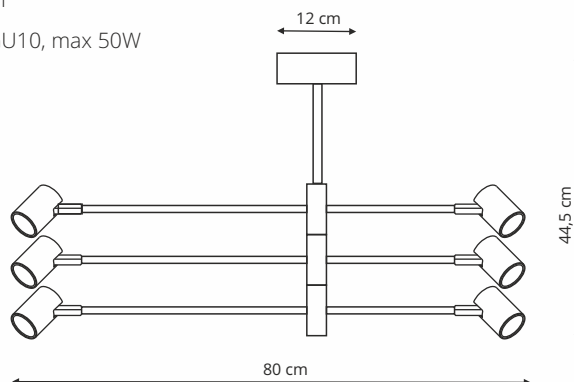

🔧 metal

💡 1 x GU10, max 50W





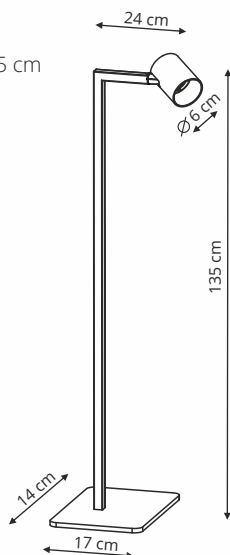

LP-731/1F biała
LP-731/1F czarna

-  sz. 14 x gł. 24 x wys. 135 cm
-  metal
-  1 x GU10, max 50W



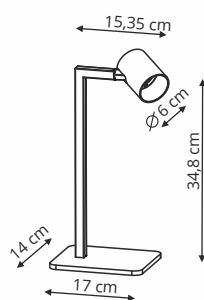

LP-731/1T biała
LP-731/1T czarna

-  sz. 14 x gł. 17 x wys. 34,8 cm
-  metal
-  1 x GU10, max 50W



LP-731/1WL biała
LP-731/1WL czarna

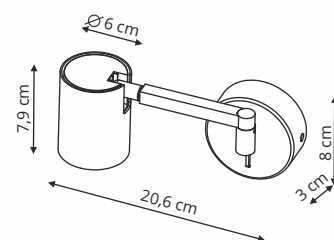

-  sz. 8 x gł. 20,6 x wys. 8 cm
-  metal
-  1 x GU10, max 50W







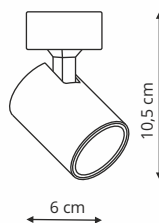

SNOW

LP-731/1W biała
LP-731/1W złota
LP-731/1W czarna

-  sz. 6 x gł. 6 x wys. 10,5 cm
-  metal
-  1 x GU10, max 50W



LP-731/2W biała
LP-731/2W złota
LP-731/2W czarna

-  sz. 25 x gł. 6 x wys. 10,5 cm
-  metal
-  2 x GU10, max 50W

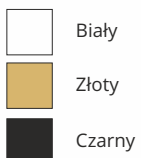
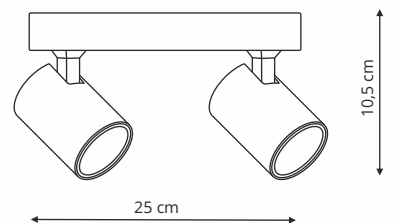





LP-731/3W biała

LP-731/3W złota

LP-731/3W czarna

-  sz. 45 x gł. 6 x wys. 10,5 cm
-  metal
-  3 x GU10, max 50W

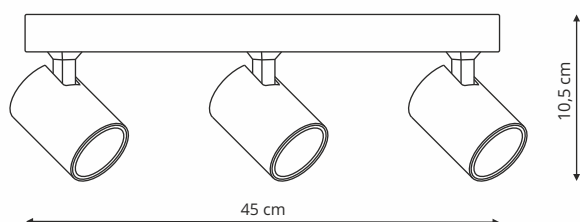

SZYNOPRZEWODY 1F



SNOW

LP-731/1R do szynoprzewodów 1F biała

LP-731/1R do szynoprzewodów 1F czarna

LP-731/1R do szynoprzewodów 1F złota

 sz. 7,85 x gł. 6 x wys. 10,5 cm

 metal

 1 x GU10, max 50W

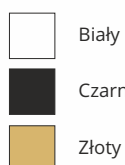
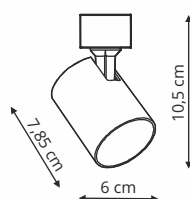





SNOW SET

Snow SET 1F biały
Snow SET 1F czarny
Snow SET 1F złoty

 sz. 2 x 75cm x gł. 2 x wys. 10,5 cm

 metal

 4 x GU10, max 50W

Szynoprzewód 2 x 75 cm, 1F

Zasilanie centralne 1F

2 x Zaślepka

Reflektor Snow GU10 x 4

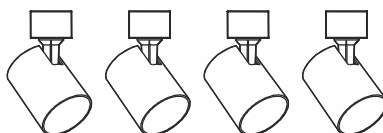

Szynoprzewód 2 x 75 cm, 1F

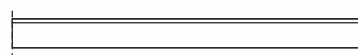

Zasilanie centralne 1F Zaślepki x 2

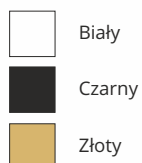

SZYNOPRZEWODY 1F



TOKIO

LP-787/1R do szynoprzewodów 1F biały
LP-787/1R do szynoprzewodów 1F czarny

 sz. 6,5 x gł. 6,5 x wys. 15 cm

 metal, plastik

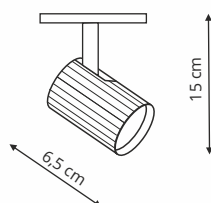

 1 x GU10, max 50W





TOKIO SET

Tokio SET 1F biały Tokio SET 1F czarny

-  sz. 2 x 100 x gł. 6,5 x wys. 16,5 cm
-  metal, plastik
-  4 x GU10, max 50W
- Szynoprzewód 2 x 100cm, 1F
- Zasilanie końcowe 1F
- 2 x Zaślepka

Reflektor Tokio x 4

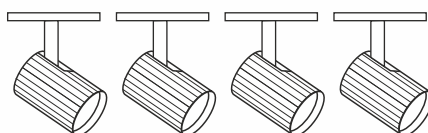

Szynoprzewód 2 x 100cm, 1F

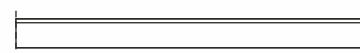

Zasilanie centralne 1F Zaślepki x 2

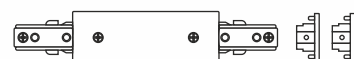

SZYNOPRZEWODY 1F



ICE

LP-732/1R do szynoprzewodów 1F biały
LP-732/1R do szynoprzewodów 1F czarny

 sz. 6,5 x gł. 6,5 x wys. 15 cm

 metal, plastik

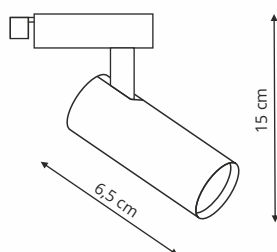

 1 x GU10, max 50W





ICE SET

Ice SET 1F biały Ice SET 1F czarny

-  sz. 2 x 75 cm x gł. 6,5 x wys. 15 cm
-  metal, plastik
-  3 x GU10, max 50W
- Szynoprzewód 2 x 75 cm, 1F
- Zasilanie centralne 1F
- 2 x Zaślepka

Reflektor Ice 1F x 3

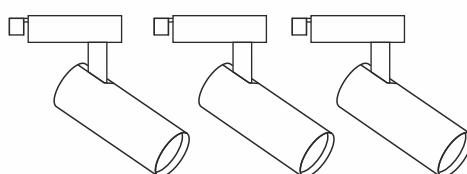

Szynoprzewód 2 x 75 cm, 1F

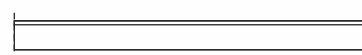

Zasilanie centralne 1F Zaślepki x 2

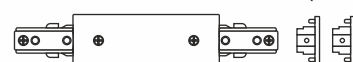

SZYNOPRZEWODY 1F

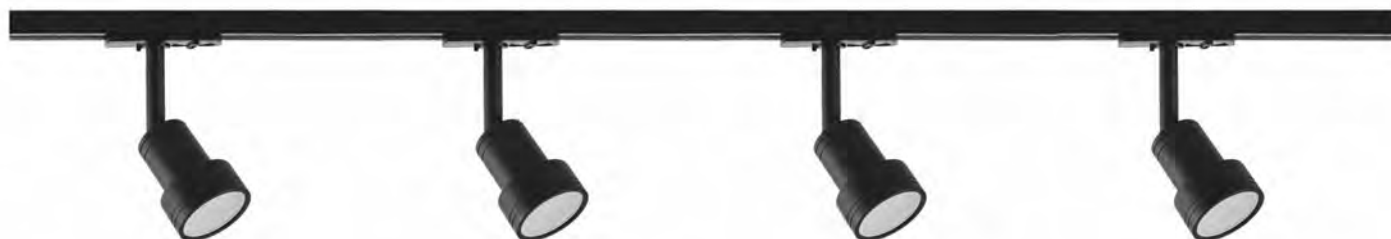

STORM

LP-733/1R do szynoprzewodów 1F biały
LP-733/1R do szynoprzewodów 1F czarny

 sz. 13,5 x gł. 5,5 x wys. 16,5 cm

 metal, plastik

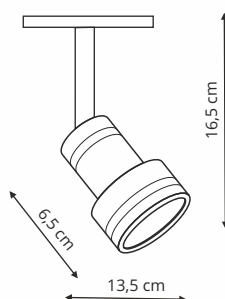

 1 x GU10, max 50W





STORM SET

Storm SET 1F biały Storm SET 1F czarny

-  sz. 150 x gł. 5,5 x wys. 16,5 cm
-  metal, plastik
-  4 x GU10, max 50W
- Szynoprzewód 1,5 m, 1F
- Zasilanie końcowe 1F
- Zaślepka

Reflektor Storm x 4

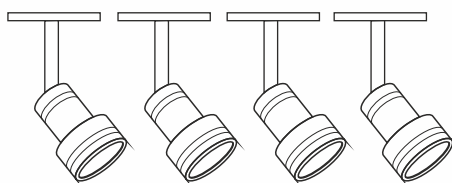

Szynoprzewód 1,5 m, 1F

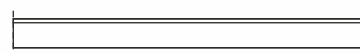

Zasilanie końcowe 1F Zaślepka

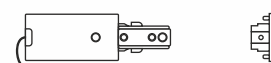



SZYNOPRZEWODY 1F



ROCCA

LP-1019/1W 1F biała

LP-1019/1W 1F czarna

-  sz. 12,5 x gł. 5 x wys. 14 cm
-  metal, plastik
-  1 x LED, 10W, 800LM,
dostępna w barwie światła
3000K lub 4000K

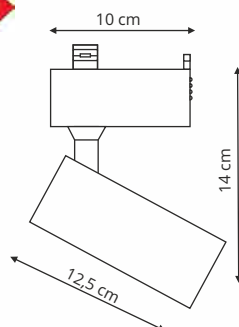

Biały





Czarny



LEON

LP-1919/1W 1F biała LP-1919/1W 1F czarna

-  sz. 7,9 x gł. 5 x wys. 11,6 cm
-  metal, plastik
-  1 x LED, 7W, 420LM, 3000 K

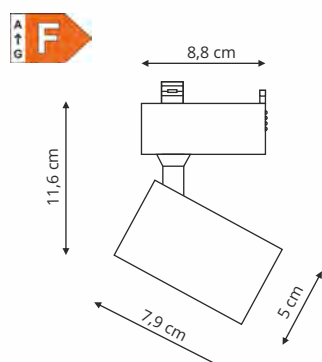

SZYNOPRZEWODY 1F



LUNGO

LP-894/1P 1F Czarny
LP-894/1P 1F Złoty

- sz. 2,5 x gł. 2,5 x wys. 150 cm
- metal
- 1 x G9 MAX 5W

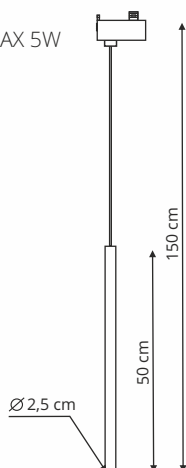

BOLA

LP-003/1R

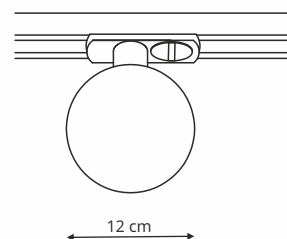

- sz. 40 x gł. 3,5 x wys. 4 cm
- metal
- 1 x LED 12W, 1020 LM
dostępna w barwie światła
3000K lub 4000K





MOON

Moon reflektor 1F LP-559 1F

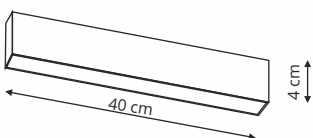

-  sz. 40 x gł. 3,5 x wys. 4 cm
-  metal
-  1 x LED 12W,1020 LM
dostępna w barwie światła
3000K lub 4000K



 Czarny



AQUILION

LP-220/1R 12W biała LP-220/1R 12W czarna

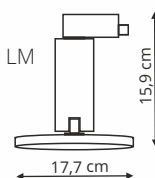
-  sz. 40 x gł. 3,5 x wys. 4 cm
-  metal
-  1 x LED 12W,1020 LM



LP-220/1R 18W biała LP-220/1R 18W czarna

-  sz. 40 x gł. 3,5 x wys. 4 cm
-  metal
-  1 x LED 18W,1020 LM

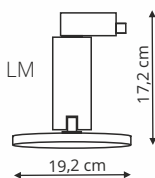

 Biały
 Czarny

SZYNOPRZEWODY 1F

Akcesoria

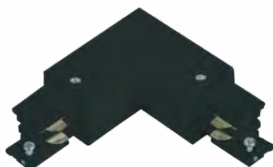

Szynoprzewód 1,5m 1F

LP-571/1,5M-S 1F biały

LP-571/1,5M-S 1F czarny

sz. 150 x gł. 3,43 x wys. 1,78 cm

metal

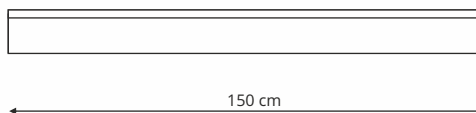

Szynoprzewód 2m 1F

LP-571/2M-S biały

LP-571/2M-S czarny

sz. 200 x gł. 3,43 x wys. 1,78 cm

metal

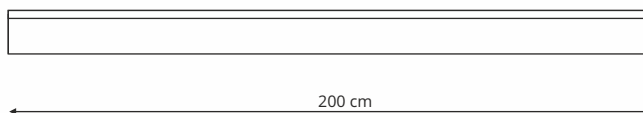

Zaślepka 1F

LP-556/END-S 1F biała

LP-556/END-S 1F czarna

sz. 1,385 x gł. 3,53 cm

metal, plastik

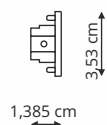

Zasilanie centralne/wewnętrzne 1F

LP-555-S 1F biały

LP-555-S 1F czarne

sz. 17,7 x gł. 3,5 cm

metal, plastik

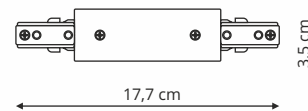

Zasilanie końcowe 1F

LP-556-S 1F biały

LP-556-S 1F czarne

sz. 10,6 x gł. 3,5 cm

metal, plastik

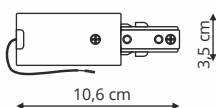

Łącznik wewnętrzny 1F

LP-551-S 1F biały

LP-551-S 1F czarny

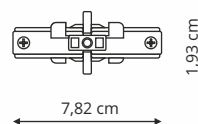

sz. 7,82 x wys. 1,93 cm

metal, plastik





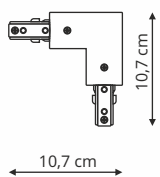

Łącznik „L” 1F
LP-552-S 1F biały
LP-552-S 1F czarny

-  sz. 10,7 x gł. 10,7 cm
-  metal, plastik



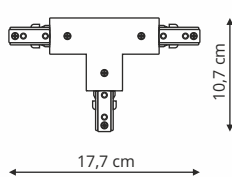

Łącznik „T” 1F
LP-553 1F biały
LP-553 1F czarny

-  sz. 17,7 x gł. 10,7 cm
-  metal, plastik



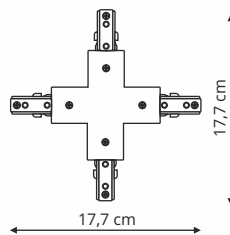

Łącznik wewnętrzny „X” 1F
LP-551 1F biały
LP-551 1F czarny

-  sz. 17,7 x gł. 17,7 cm
-  metal, plastik



Adapter do lamp wiszących 1F
LP-A340S 1F biały
LP-A340S 1F czarny

-  sz. 6 x gł. 3,5 cm
-  metal, plastik

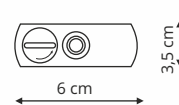

SZYNOPRZEWODY 3F



ICE

LP-732/1R 3F biały
LP-732/1R 3F czarny

- ↗ sz. 6,5 x gł. 6,5 x wys. 15 cm
- 🔧 metal, plastik
- 💡 1 x GU10, max 50W

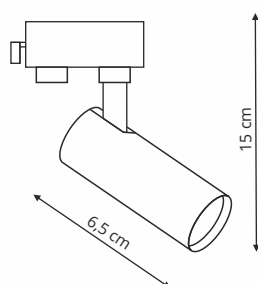

MAGNUM

LP-8120/1R 3F 3F biały
LP-8120/1R 3F 3F czarny

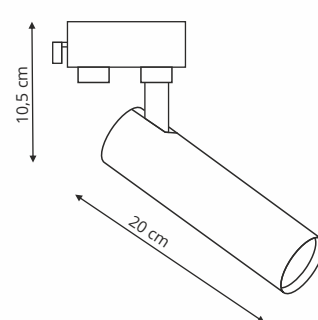

- ↗ sz. 6,5 x gł. 6,5 x wys. 15 cm
- 🔧 metal, plastik
- 💡 1 x GU10, max 50W





MOON

Moon reflektor 3F
LP-559/3 R-3F Czarny 3000K
LP-559/4 R-3F Czarny 4000K

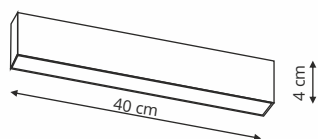

-  sz. 40 x gł. 3,5 x wys. 4 cm
 -  metal
 -  1 x LED 12W, 1020 LM
- dostępna w barwie światła
3000K lub 4000K



 Czarny

LUNGO

LP-894/1P 3F Czarny
LP-894/1P 3F Złoty

-  sz. 2,5 x gł. 2,5 x wys. 150 cm
-  metal
-  1 x G9 max 5W

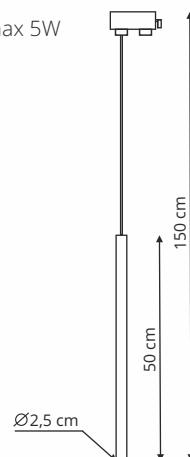

 Złoty
 Czarny

SZYNOPRZEWODY 3F

Akcesoria

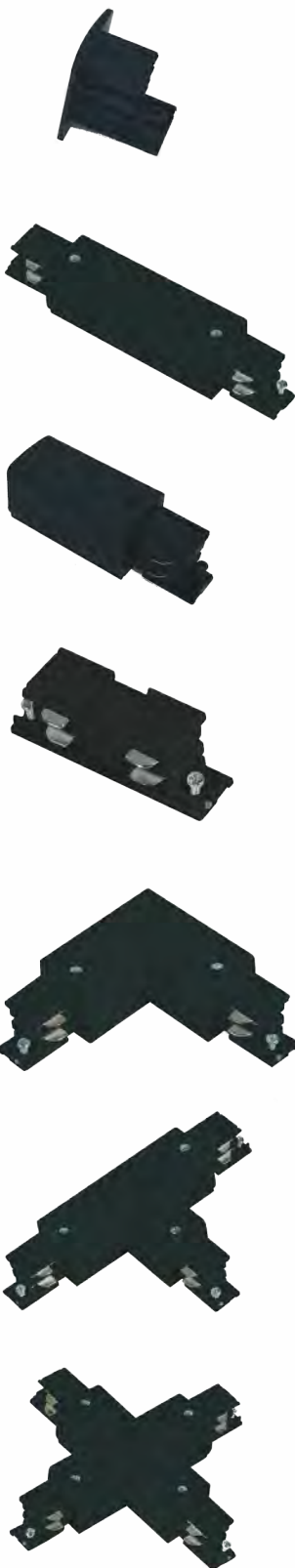

Szynoprzewód 1m 3F

LP-571/1M-3F biały

LP-571/1M-3F czarny

sz. 100 x gł. 3,5 x wys. 3,5 cm

metal

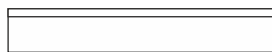

100 cm

Szynoprzewód 2m 3F

LP-571/2M-3F biały

LP-571/2M-3F czarny

sz. 200 x gł. 3,5 x wys. 3,5 cm

metal

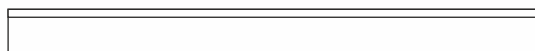

200 cm

Zaślepka 3F

LP-556/END-3F biała

LP-556/END-3F czarna

sz. 1,385 x gł. 3,53 cm

metal, plastik

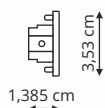

Zasilanie centralne/wewnętrzne 3F

LP-555-3F białe

LP-555-3F czarne

sz. 17,7 x gł. 3,5 cm

metal, plastik

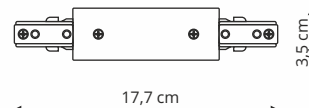

Zasilanie końcowe 3F

LP-556-3F białe

LP-556-3F czarne

sz. 10,6 x gł. 3,5 cm

metal, plastik

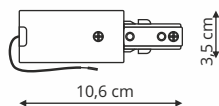

Łącznik wewnętrzny 3F

LP-551-3F biały

LP-551-3F czarny

sz. 7,82 x wys. 1,93 cm

metal, plastik

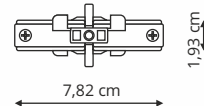



Łącznik „L” 3F lewy
LP-552-3F L biały
LP-552-3F L czarny

sz. 10,7 x gł. 10,7 cm
 metal, plastik

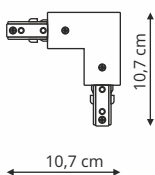

Łącznik „L” 3F prawy
LP-552-3F R biały
LP-552-3F R czarny

sz. 10,7 x gł. 10,7 cm
 metal, plastik

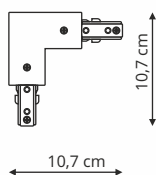

Łącznik „T” 3F
LP-553-3F biały
LP-553-3F czarny

sz. 17,7 x gł. 10,7 cm
 metal, plastik

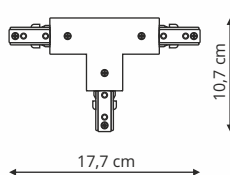

Łącznik wewnętrzny „X” 3F
LP-551-3F biały

sz. 17,7 x gł. 17,7 cm
 metal, plastik

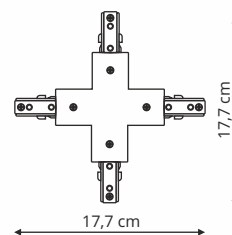

SZYNOPRZEWODY MAGNETIC

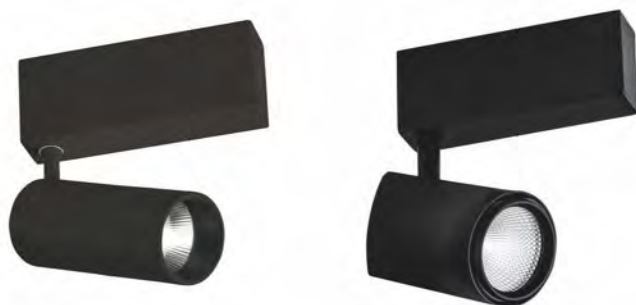

MAGNETIC

Sun 1 reflektor Magnetic czarny LP-557-MAG- czarny

sz. 14,8 x gł. 3,4 x wys. 14,5 cm

metal

1 x LED, 15W, 880 LM, 3000 K

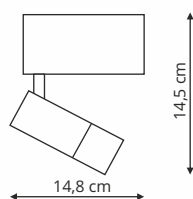

Czarny

Sun 3 reflektor Magnetic czarny LP-558-MAG- czarny

sz. 21,5 x gł. 3,4 x wys. 15,3 cm

metal

1 x LED, 15W, DC 24V, 890 LM, 3000 K

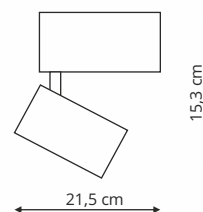

Czarny





**Bilbao 3 spot magnetic czarny
LP-563-MAG- czarny**

sz. 33,7 x gł. 3,9 x wys. 9,4 cm

metal

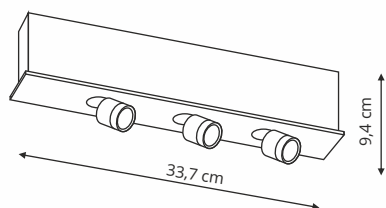
3 x LED, 3W, 700 LM, 3000 K



 Czarny / Biały

Lunar reflektor Magnetic czarny

LP-561-MAG- czarny

sz. 16,4 x gł. 3,4 x wys. 18,1 cm

metal

6 x LED, max 1W, 390 LM, 3000 K

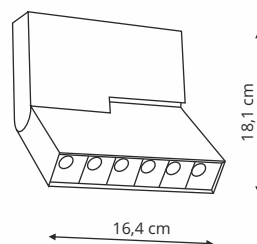

 Biały
 Czarny

SZYNOPRZEWODY MAGNETIC



MAGNETIC

* Szyna jest zasilana 24V, zasilacz jest montowany po za oprawą, jest sprzedawany oddzielnie.

Szyna Magnetic LP-E020-MAG- czarna

sz. 200 x gł. 4 x wys. 7,5 cm

metal

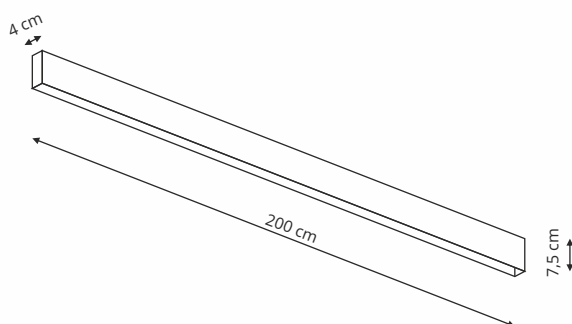

Star 3 reflektor Magnetic LP-556-MAG- czarny

sz. 9,4 x gł. 3,4 x wys. 5,6 cm

metal

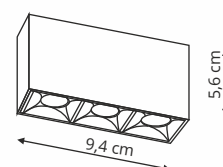

3 x LED, 1W, DC 24V, 210 LM, 3000 K



Czarny



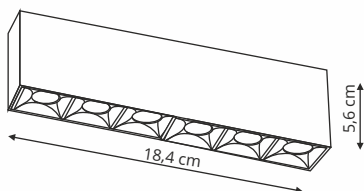

**Star 6 reflektor Magnetic
LP-556-MAG- czarny**

-  sz. 18,4 x gł. 3,4 x wys. 5,6 cm
-  metal
-  6 x LED, 1W, DC 24V, 210 LM, 3000 K



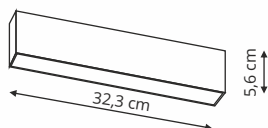

**Moon reflektor 10W Magnetic
LP-559-MAG- czarny**

-  sz. 32,3 x gł. 3,4 x wys. 5,6 cm
-  metal
-  1 x LED, 10W, 610 LM,
dostępna w barwie światła
3000K lub 4000K



**Moon reflektor 20W Magnetic
LP-560-MAG- czarny**

-  sz. 60 x gł. 3,4 x wys. 5,6 cm
-  metal
-  1 x LED, 20W, 850 LM,
dostępna w barwie światła
3000K lub 4000K

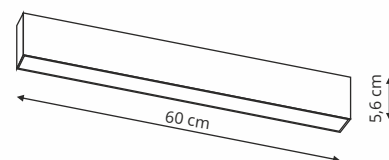

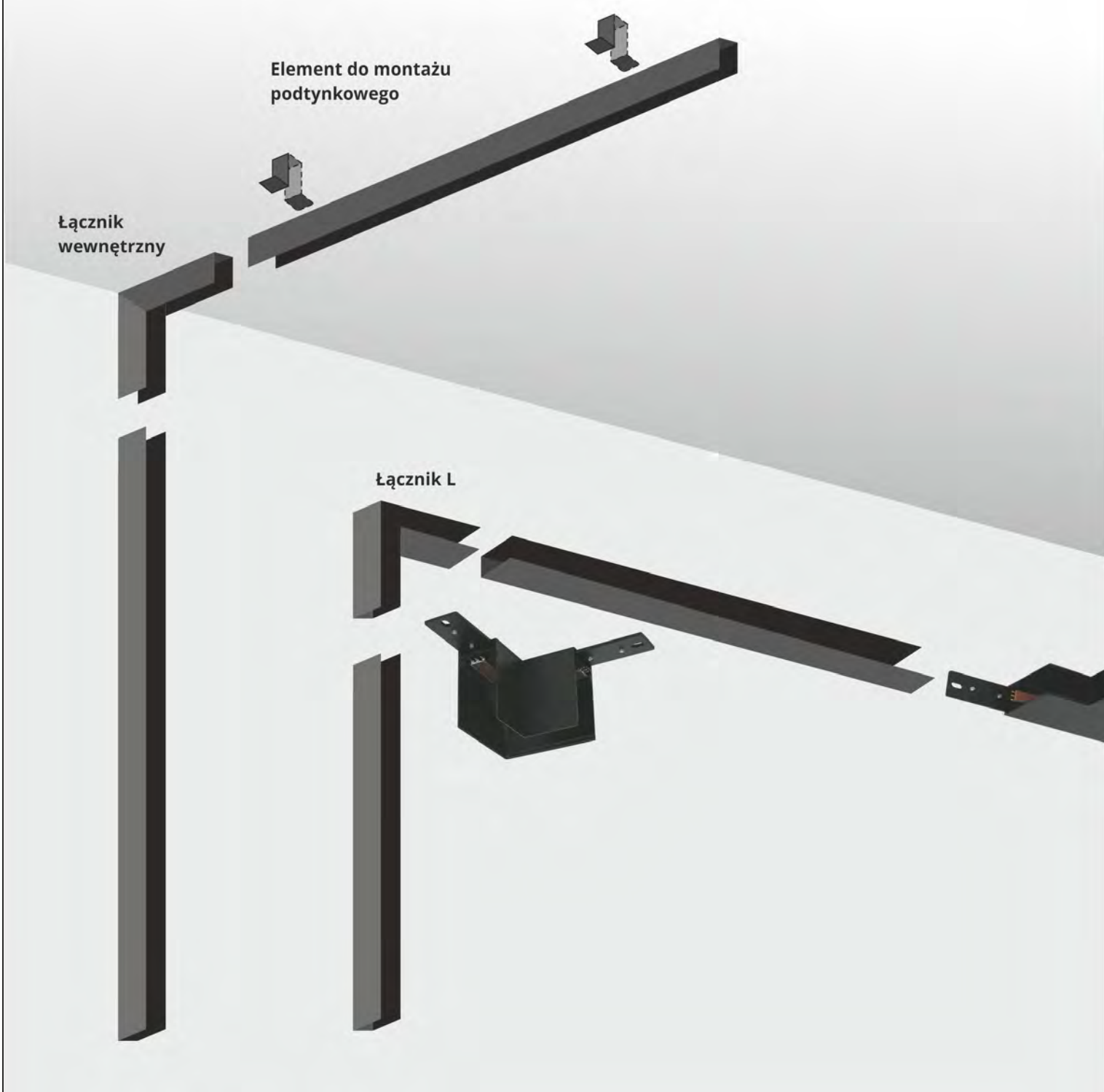

MAGNETIC

Łącznik L Magnetic czarny LP-552-MAG- czarny

- sz. 14,8 x gł. 14,8 cm
- metal

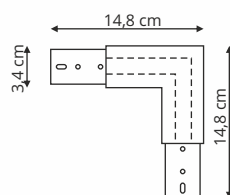

Łącznik wewnętrzny Magnetic czarny LP-553-MAG- czarny

- sz. 18,3 x gł. 18,3 cm
- metal

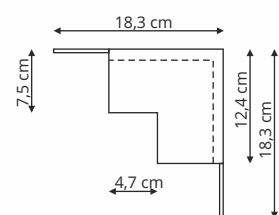

Czarny

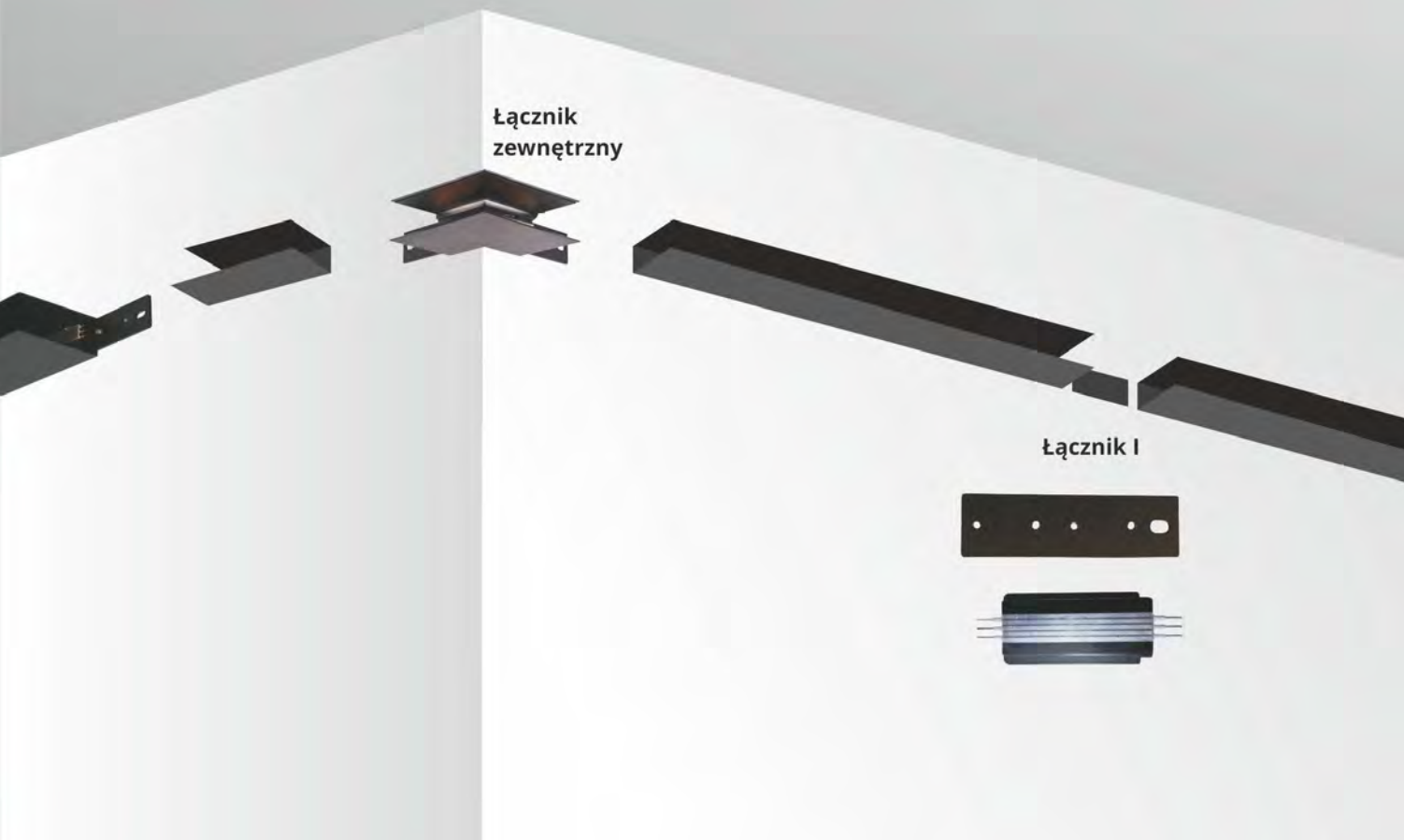

Łącznik zewnętrzny

Łącznik I

**Łącznik zewnętrzny
Magnetic czarny
LP-554-MAG- czarny**

sz. 18,5 x gł. 19 cm
metal

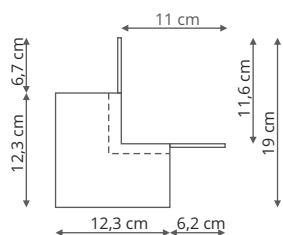

**Łącznik I
Magnetic czarny
LP-551-MAG- czarny**

sz. 13 x gł. 3,2 cm
metal

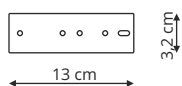

**Magnetic Electric Plate
element łączący szyny
LP-564-MAG**

sz. 6,8 x gł. 3 cm
metal

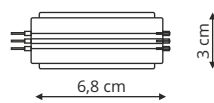

**Zestaw do montażu
podtynkowego
LP-E020-MAG-R KIT
zestaw podtynkowy**

sz. 10,3 x gł. 6,5 cm
metal

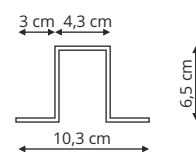

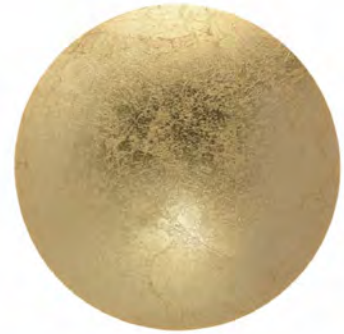

PLATILLO

LP-8102/1C-6W biała
LP-8102/1C-6W złota
LP-8102/1C-6W czarna

 sz. 16 x gł. 3,65 x wys. 16 cm

 metal

 LED 6W 3000K 570 LM

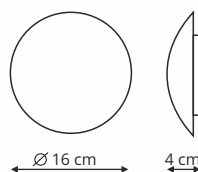

LP-8102/1C-12W biała
LP-8102/1C-12W złota
LP-8102/1C-12W czarna

 sz. 21 x gł. 4 x wys. 21 cm

 metal

 LED 12W 3000K 1140 LM

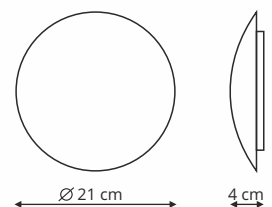



LP-8102/1C-18W biała

LP-8102/1C-18W złota

LP-8102/1C-18W czarna

 sz. 26 x gł. 4,5 x wys. 26 cm

 metal

 LED 18W 3000K 1710 LM

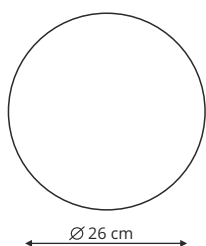





MODERN SLIM

Produkt posiada certyfikat



-  Biały
-  Złoty
-  Czarny
-  Chrom

- LP-777/1W M 6W biała
- LP-777/1W M 6W złota
- LP-777/1W M 6W czarna
- LP-777/1W M 6W chrom

-  sz. 40 x gł. 7,2 x wys. 5 cm
-  metal, akryl
-  1 x LED, 6W, 800 LM, 3000K

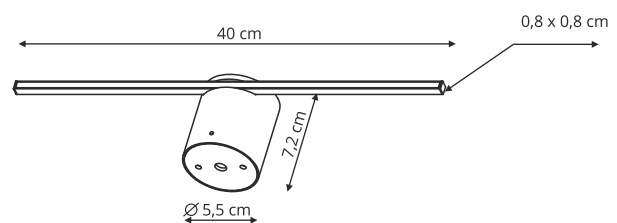



LP-777/1W M 8W biała
LP-777/1W M 8W złota
LP-777/1W M 8W czarna
LP-777/1W M 8W chrom

 sz. 60 x gł. 7,2 x wys. 5,5 cm

 metal, akryl

 1 x LED, 8W, 1100 LM, 3000K

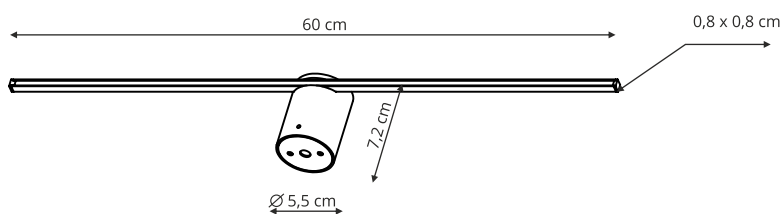





MIRROR

Produkt posiada certyfikat



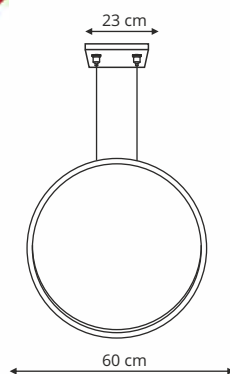

LP-999/1P S mała czarna
LP-999/1P S mała złota

-  sz. 60 x wys. 150 cm
-  metal
-  1 x LED 35W, 3000K, 1820LM,



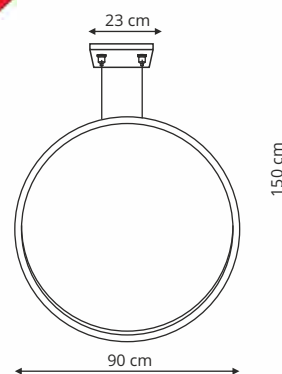

LP-999/1P L duża czarna
LP-999/1P L duża złota

-  sz. 90 x wys. 150 cm
-  metal
-  1 x LED 50W, 3000K, 2600LM,





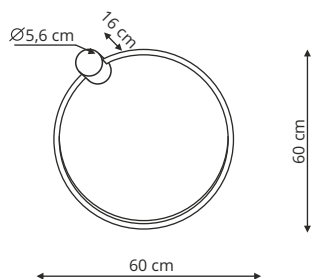

LP-999/1W S kinkiet LED mały czarny

-  sz. 60 x gł. 16 wys. 60 cm
-  metal
-  1 x LED 35W, 3000K, 1820LM,



LP-999/1W L kinkiet LED duży czarny

-  sz. 90 x gł. 16 wys. 90 cm
-  metal
-  1 x LED 50W, 3000K, 2600LM,

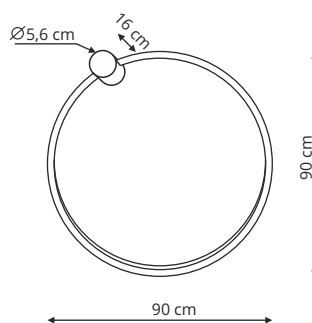



ISLA

Produkt posiada certyfikat



- Biały
- Złoty
- Czarny
- Chrom

GS-LWB-12W biała
GS-LWB-12W złota
GS-LWB-12W czarna
GS-LWB-12W chrom

- sz. 41 x gł. 14 x wys. 5 cm
- metal
- 1 x LED, 12W, 840 LM,
dostępna w barwie światła
3000K lub 4000K

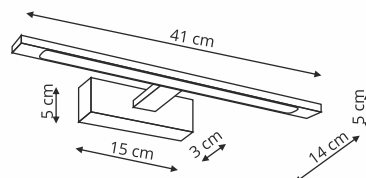

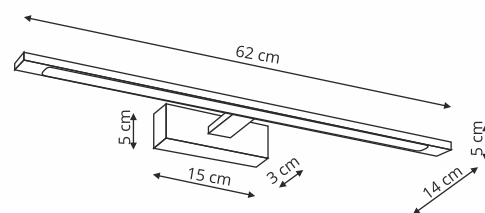

GS-LWB-20W biała
GS-LWB-20W złota
GS-LWB-20W czarna
GS-LWB-20W chrom

- sz. 62 x gł. 14 x wys. 5 cm
- metal
- 1 x LED, 20W, 1400 LM,
dostępna w barwie światła
3000K lub 4000K





GS-LWB-32W biała
GS-LWB-32W czarna
GS-LWB-32W chrom

-  sz. 96 x gł. 14 x wys. 5 cm
-  metal
-  1 x LED, 32W, 2240 LM, 4000K

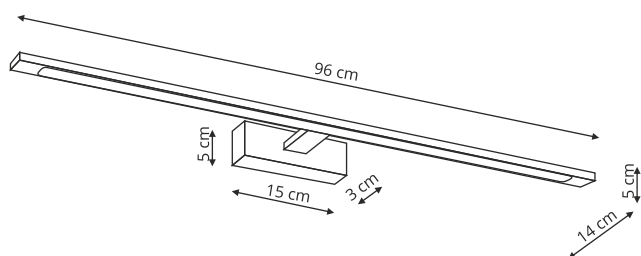





IBROS

Produkt posiada certyfikat



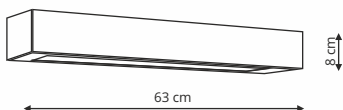

Plafon LP-7001/1C biała 63 LP-7001/1C czarna 63

-  sz. 63 x gł. 5,5 x wys. 8 cm
-  metal, akryl
-  1 x LED, 18W, 1140LM, dostępna w barwie światła 3000K lub 4000K



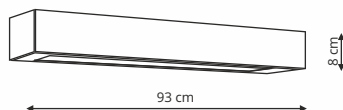

Plafon LP 7001/1C biała - 93 LP 7001/1C czarna - 93

-  sz. 93 x gł. 5,5 x wys. 8 cm
-  metal, akryl
-  1 x LED 24W, 1920LM, dostępna w barwie światła 3000K lub 4000K



Plafon LP 7001/1C biała - 120 LP 7001/1C czarna - 120

-  sz. 120 x gł. 5,5 x wys. 8 cm
-  metal, akryl
-  1 x LED 24W, 1920LM, dostępna w barwie światła 3000K lub 4000K

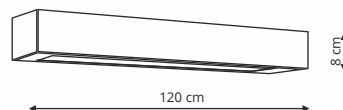



Biały



Czarny



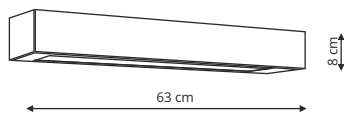

Kinkiet
GS-LWA-9W biała
GS-LWA-9W czarna

-  sz. 63 x gł. 5,5 x wys. 8 cm
-  metal, akryl
-  1 x LED, 9W, 720 LM, 4000K



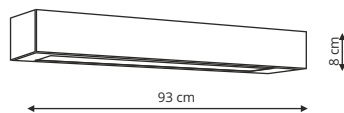

Kinkiet
GS-LWA-12W biała
GS-LWA-12W czarna

-  sz. 93 x gł. 5,5 x wys. 8 cm
-  metal, akryl
-  1 x LED 12W, 960 LM, 4000 K



Kinkiet
GS-LWA-18W biała
GS-LWA-18W czarna

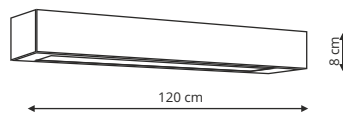

-  sz. 93 x gł. 5,5 x wys. 8 cm
-  metal, akryl
-  1 x LED 18W, 1440 LM, 4000 K

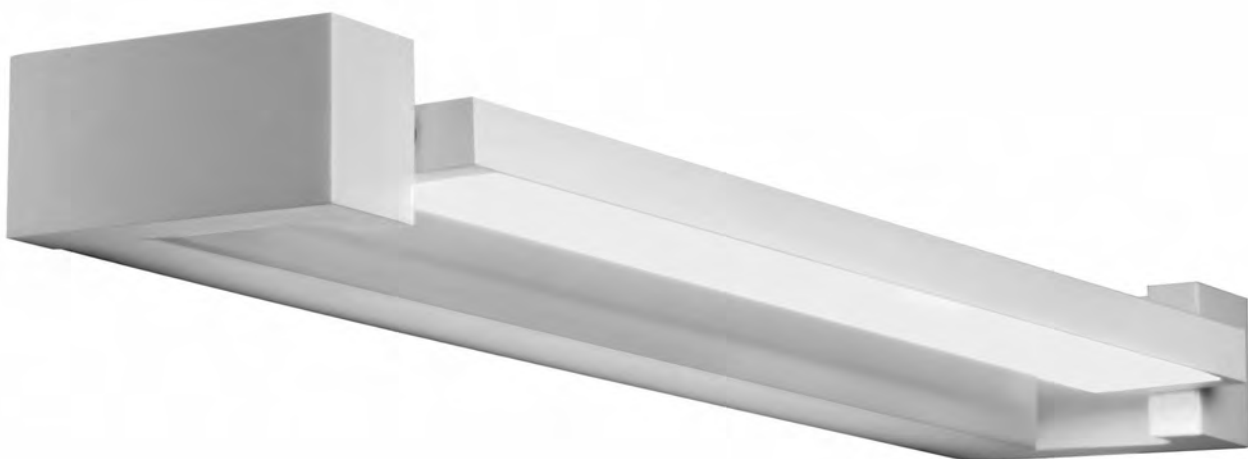



DENVER

LP-1375/1W 20W

-  sz. 57 x gł. 8 x wys. 3 cm
-  metal
-  1 x LED 20W, 4000 K, 1800 LM

Produkt posiada certyfikat

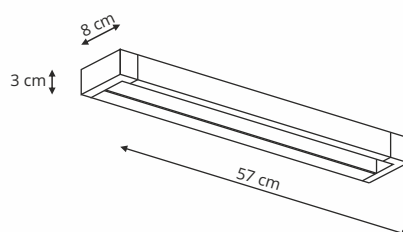



Biały



CARGO

LP-1173/1W 20W

-  sz. 70 x gł. 9 x wys. 4,2 cm
-  metal
-  1 x LED 20W, 4000 K, 1800 LM



Produkt posiada certyfikat

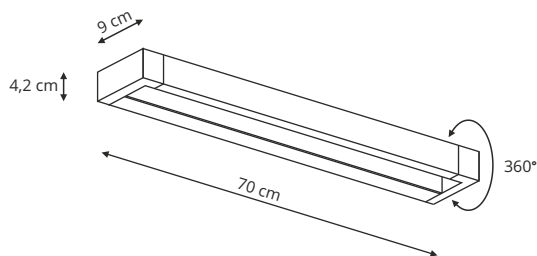







 Biały







BOSTON

Oprawy z serii BOSTON dostępne są w następujących kombinacjach kolorystycznych

-  Czarny
-  Czarny / Biały
-  Czarny / Złoty
-  Biały
-  Biały / Czarny
-  Biały / Złoty



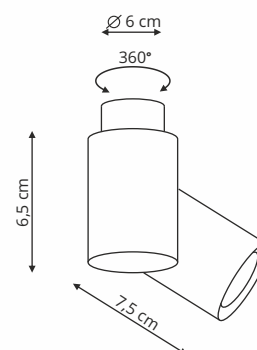

- LP-741/1W biała**
- LP-741/1W biało / złota**
- LP-741/1W biało / czarna**
- LP-741/1W czarna**
- LP-741/1W czarno / złota**
- LP-741/1W czarno / biała**

-  tuba: śr. 6 x wys. 7,5 cm
-  podstawa: śr. 6 x wys. 6,5 cm
-  metal
-  1 x GU10, max 50W





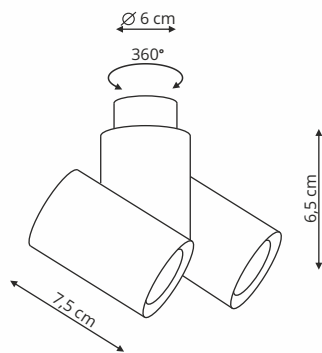

- LP-741/2W biała**
- LP-741/2W biało / złota**
- LP-741/2W biało / czarna**
- LP-741/2W czarna**
- LP-741/2W czarno / złota**
- LP-741/2W czarno / biała**

-  tuba: śr. 6 x wys. 7,5 cm
-  podstawa: śr. 6 x wys. 6,5 cm
-  metal
-  2 x GU10, max 50W



- LP-741/ ring biały**
- LP-741/ ring złoty**
- LP-741/ ring czarny**

-  sz. 6 x gł. 6 cm
-  metal





Dostępne kolory ring







MANACOR

Oprawy z serii MANACOR dostępne są w następujących kombinacjach kolorystycznych



-  Czarny
-  Czarny / Biały
-  Czarny / Złoty
-  Biały
-  Biały / Czarny
-  Biały / Złoty

- LP-232/1D-90 biała**
- LP-232/1D-90 biało / złota**
- LP-232/1D-90 biało / czarna**
- LP-232/1D-90 czarna**
- LP-232/1D-90 czarno / złota**
- LP-232/1D-90 czarno / biała**

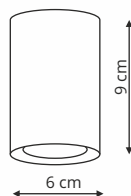
-  sz. 6 x gł. 6 x wys. 9 cm
-  metal
-  1 x GU10, max 50W



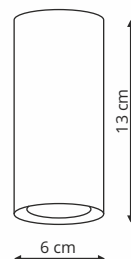

- LP-232/1D-130 biała**
- LP-232/1D-130 biało / złota**
- LP-232/1D-130 biało / czarna**
- LP-232/1D-130 czarna**
- LP-232/1D-130 czarno / złota**
- LP-232/1D-130 czarno / biała**

-  sz. 6 x gł. 6 x wys. 13 cm
-  metal
-  1 x GU10, max 50W





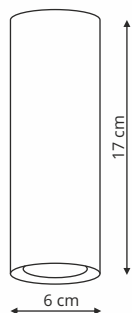

LP-232/1D-170 biała
LP-232/1D-170 biała / złota
LP-232/1D-170 biała / czarna
LP-232/1D-170 czarna
LP-232/1D-170 czarna / złota
LP-232/1D-170 czarna / biała

-  sz. 6 x gł. 6 x wys. 17 cm
-  metal
-  1 x GU10, max 50W



LP-232/ ring biały
LP-232/ ring złoty
LP-232/ ring czarny

-  sz. 6 x gł. 6 cm
-  metal



Dostępne kolory ring

Biały



Złoty



Czarny







OPRAWY ŁAZIENKOWE



FARO

LP-6510/1SM biała
LP-6510/1SM czarna

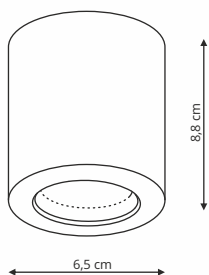

-  sz. 6,5 x gł. 6,5 x wys. 8,8 cm
-  metal
-  1 x GU10, max 50W

Produkt posiada certyfikat  IP 65



FARO XL

LP-6510/1SM XL biała
LP-6510/1SM XL czarna

-  sz. 9 x gł. 9 x wys. 9,5 cm
-  metal
-  1 x GU10, max 50W

Produkt posiada certyfikat  IP 65

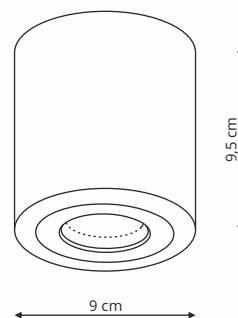



KENDAL

* możliwość zmiany barwy światła
w przedziale 3000K - 6000K

LP-6331/1SM biała LP-6331/1SM czarna

↗ sz. 9 x gł. 9 x wys. 5,7 cm

🔧 aluminium

💡 1 x LED 6W, 490 LM, 3000K *



Produkt posiada certyfikat

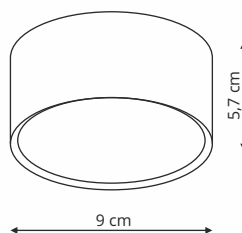

Biały



Czarny



METIS

* minimalna głębokość
zabudowy g/k 80mm



LP-2780/1RS biała LP-2780/1RS czarna

↙ sz. 9,15 x gł. 9,15 x wys. 2,5 cm

🔧 metal

💡 1 x GU10, max 50W

Wielkość otworu montażowego 80 mm

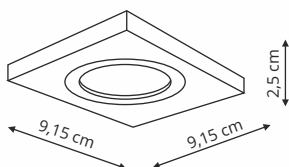

LP-2780/2RS biała LP-2780/2RS czarna

↙ sz. 18,5 x gł. 9,15 x wys. 2,5 cm

🔧 metal

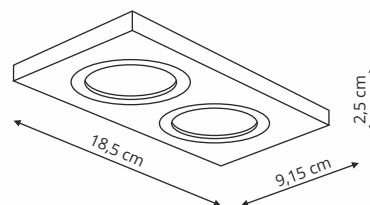

💡 2 x GU10, max 50W





LAGOS

LP-440/1RS biała ruchoma
LP-440/1RS czarna ruchoma

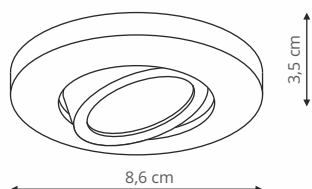

-  sz. 8,6 x gł. 8,6 x wys. 3,5 cm
-  metal
-  1 x GU10, max 50W

Wielkość otworu montażowego 75 mm



ORION

LP-4434/1RS biała
LP-4434/1RS czarna

-  sz. 9 x gł. 9 x wys. 4,5 cm
-  metal, plastik
-  1 x LED, max 8W



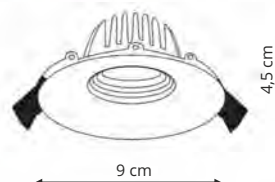

* przełącznik barwy światła
 3000K ← → 4000K

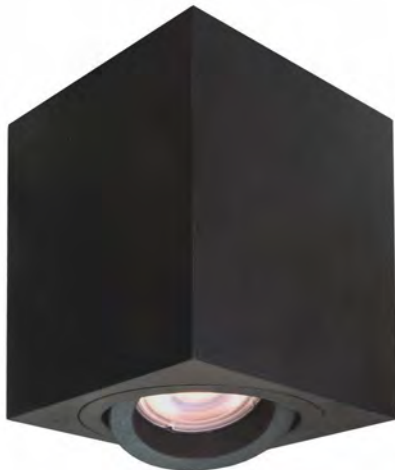





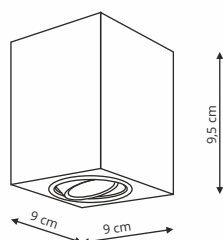

LYON

LP-5881/1SM biała
LP-5881/1SM czarna

-  sz. 9 x gł. 9 x wys. 9,5 cm
-  metal
-  1 x GU10, max 50W



LP-5881/2SM biała
LP-5881/2SM czarna

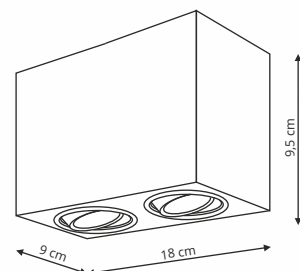

-  sz. 9 x gł. 18 x wys. 9,5 cm
-  metal
-  2 x GU10, max 50W





TULON

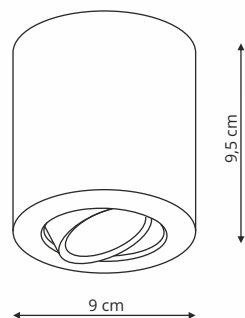

LP-5441/1SM biała
LP-5441/1SM czarna

-  sz. 9 x gł. 9 x wys. 9,5 cm
-  aluminium
-  1 x GU10, max 50W



KENDAL

LP-6331/1SM biała
LP-6331/1SM czarna

-  sz. 9 x gł. 9 x wys. 5,7 cm
-  aluminium
-  1 x LED 6W, 490 LM, 3000 K

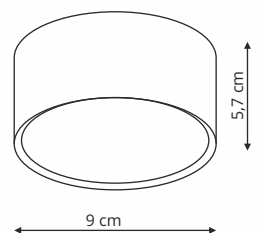

OCZKA ŁAZIENKOWE



LAGOS

* minimalna głębokość
zabudowy g/k 80 mm

LP-440/1RS biała kwadratowa IP65
LP-440/1RS czarna kwadratowa IP65

 sz. 7,7 x gł. 7,7 x wys. 2,2 cm

 metal

 1 x GU10, max 50W

Wielkość otworu montażowego 60 mm

Produkt posiada certyfikat

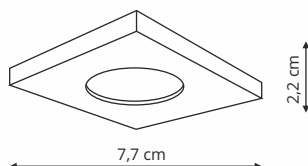



LP-440/1RS biała okrągła IP65
LP-440/1RS czarna okrągła IP65

 sz. 7,6 x gł. 7,6 x wys. 3,8 cm

 metal

 1 x GU10, max 50W

Wielkość otworu montażowego 60 mm

Produkt posiada certyfikat 

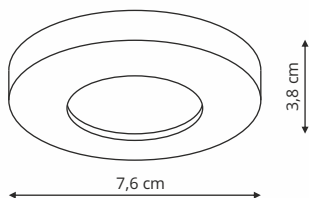

LP-4425/1RM biała ruchoma IP65
LP-4425/1RM czarna ruchoma IP65

 sz. 9,5 x gł. 9,5 x wys. 4,5 cm

 metal

 1 x GU10, max 50W

Wielkość otworu montażowego 75 mm

Produkt posiada certyfikat 

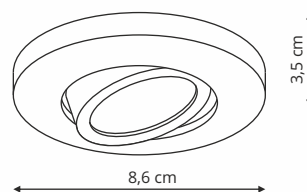



NERO

* minimalna głębokość
zabudowy g/k 80 mm

LP-4424/1RS białe ruchome
LP-4424/1RS czarne ruchome

 sz. 14,3 x gł. 14,3 x wys. 2 cm

 metal

 1 x AR111 GU10 max 50W

Wielkość otworu montażowego 135 mm

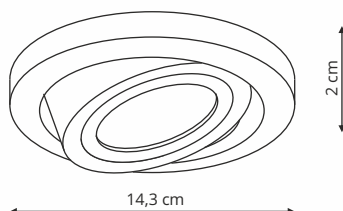



CAMINO

LP-6331/1SM biała
LP-6331/1SM czarna

 sz. 9 x gł. 9 x wys. 5,7 cm

 aluminium

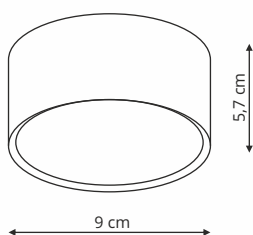

 1 x GU10 ES11





ŻARÓWKI





Żarówka GU10 9W
LP-AR111-9W 3000K biała
LP-AR111-9W 3000K czarna
LP-AR111-9W 4000K biała
LP-AR111-9W 4000K czarna

-  sz. 11,1 x wys. 5,8 cm
-  akryl
-  GU10, 9W, 900LM
- Dostępne barwy światła
3000K / 4000K

Żarówka GU10 9W
LP-AR111-9W SV 3000K
LP-AR111-9W SV 4000K

-  sz. 11,1 x wys. 5,8 cm
-  plastik, aluminium
-  GU10, 9W, 4000K, 900LM
- Dostępne barwy światła
3000K / 4000K

Żarówka GU10 6W
LP-GU10-6W 3000K GLASS

-  sz. 5 x wys. 5,3 cm
-  szkło
-  GU10 6W 3000K

TAŚMY LED



Żarówka E27 9W LP-A60-9W

- sz. 6 x wys. 11,7 cm
- plastik, aluminium
- A60 E27 9W 3000K

Żarówka LED G9 3W LP-G9-3000K

- sz. 2 x gł. 2 x wys. 5 cm
- plastik
- LED G9, 3W, 3000K, 300LM

Produkt posiada certyfikat



Taśma LED IP65 4000K

- 100 cm
- metal, plastik
- 120 sztuk LED-ów na metr
9,6 W/mb, całość max 48 W/rolka
- * CRI 80, typ diody LED - 2835
wymagany jest transformator na 24V

Taśma LED IP65 3000K

- 100 cm
- metal, plastik
- 120 sztuk LED-ów na metr
9,6 W/mb, całość max 48 W/rolka
- * CRI 80, typ diody LED - 2835
wymagany jest transformator na 24V



CLOUDS

Produkt posiada certyfikat



Odporność na temperatury od -50°C do +70°C

Wytrzymałość na uderzenia do 190 kg/cm²

LP-3519-600

 sz. 60 x gł. 60 x wys. 30 cm

 akryl

 1 x E27, max 60W

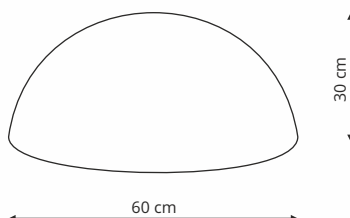

Biały



Indeks alfabetyczny produktów

<i>Kod produktu</i>	Nazwa	<i>Strona</i>	<i>Kod produktu</i>	Nazwa	<i>Strona</i>
LP-104	ALASKA	160	LP-622	MALAGA	111
LP-005	ALISA	19	LP-1015	MALAWI	45
LP-81008	ALTO	119	LP-232 P	MANACOR	39
LP-220	AQUILION	184	LP-232	MANACOR OPRAWY	211
LP-133	ARETTE	25	LP-332	MARBELLA	123
LP-1420	AREZZO	158	LP-126	MELT	89
LP-074	ARIZONA	63	LP-2780	METIS	215
LP-1122	ASTAMA	157	LP-033	MIDWAY	5
LP-1322, LP-5031	BALI	113	LP-033	MIDWAY SHINY	3
LP-003	BOLA	183	LP-866 P	MIELE WISZĄCA	35
LP-741	BOSTON	209	LP-866 T, W	MIELE STOŁOWA I PODŁOGOWA	37
LP-1111	BOVINO	69	LP-021	MILK	115
LP-101335	BURGO	67	LP-999	MIRROR	201
LP-PD024	BUTTERFLY	152	LP-777	MODERN SLIM	199
LP-6331	CAMINO	222	LP-5005	MONA	137
LP-6704	CANARIA	75	LP-2210	MONTANA	79
LP-1114	CANTOS	145	LP-2323	MONZA	80
LP-1173	CARGO	208	LP-559 1F	MOON 1F	184
LP-1864	CARRARA	79	LP-559 3F	MOON 3F	188
LP-2118	CASOLI	129	LP-4146	NAPOLI	103
LP-114	CECINA	127	LP-4424	NERO	221
LP-3519	CLOUDS	225	LP-567	NIKI	93
LP-2940	CRISTALLO	143	LP-076	NOLA	104
LP-2121	DAKOTA	128	LP-106	OREGON	159
LP-8144	DELOS	109	LP-4434	ORION	216
LP-1174	DENVER	207	LP-2844	PALLA	27
LP-002 BL	DORADO BLACK	13	LP-939	PIEGA	31
LP-002 GD	DORADO GOLD	11	LP-8102	PLATILLO	197
LP-002 C	DORADO C	15	LP-004	PUERTO	23
LP-002 T, F	DORADO T, F	17	LP-2014	RAME	95
LP-123	DRITTO	105	LP-433	RAPIDO	165
LP-075	ESTRELLA	99	LP-8069	REUS	57
LP-3439	FARFALLA	153	LP-8069	REUS led	55
LP-6510	FARO	213	LP-8069	REUS SPOT	59
LP-6510 XL	FARO XL	213	LP-909	RING	7
LP-17060	FERRARA	47	LP-10192 1F	ROCCA SZYNY 1F	181
LP-010	FLOWER	49	LP-1345	ROMA	21
LP-686	FLOWERS	151	LP-642	ROPE LIGHT	51
LP-1214	FONDI	91	LP-044	RUBI	149
LP-980	FRAME	61	LP-119	SADA	77
LP-17001	FUTURO	155	LP-1556	SAPRI	162
LP-2383	GALACTICO	87	LP-707	SAVONA	30
LP-38069	GALAXY	85	LP-2021	SENISE	131
LP-049	GEORGIA	163	LP-731 1F	SNOW 1F	173
LP-979	GLAMOUR	33	LP-731 C	SNOW PLAFON	169
LP-077	GRAFITTI	147	LP-731 W	SNOW SPOTY	171
LP-940	HALIFAX	9	LP-90082	SOLETO	101
LP-043	HUDSON	121	LP-181	SOLIN CZARNY, SZARY, BIAŁY	71
LP-7001 W	IBROS KINKIET	205	LP-181	SOLIN ŻŁOTY, CZARNO ŻŁOTY	73
LP-7001 C	IBROS PLAFON	205	LP-733 1F	STORM SZYNY 1F	179
LP-7001 P	IBROS WISZĄCY	53	LP-818	SUNFLOWER	117
LP-732 1F	ICE 1F	177		Szynoprzewody AKCESORIA 1F	185
LP-732 3F	ICE 3F	187		Szynoprzewody AKCESORIA 3F	189
LP-1053	ISLA	203	LP-1515	TAMIZA	125
LP-023	JET	107	LP-6756	TARRAGONA	76
LP-052	JUKON	97	LP-STRIP LED	TAŚMY LED	223
LP-6331	KENDAL	214	LP-1133	TIVOLI	130
LP-6331	KENDAL	214	LP-787	TOKIO	43
LP-6331	KENDAL	218	LP-787 1F	TOKIO SZYNY 1F	175
LP-055	KONSTELACJA	81	LP-108	TORINO	161
LP-440	LAGOS	216	LP-798	TREVISO	83
LP-440, LP-4425	LAGOS IP65	219	LP-5441	TULON	218
LP-1919	LEON 1F	182	LP-2910	VETRO	139
LP-2960	LORENZO	29	LP-2910 GD	VETRO GOLD	141
LP-2526	LORIA	167	LP-0412	VIGO	135
LP-2828	LUGANO	65	LP-330	YORK	168
LP-894	LUNGO	41	LP-1243	ZIG-ZAG	133
LP-894 1F	LUNGO 1F	183		ŻARÓWKI	223
LP-894 3F	LUNGO SZYNY 3F	188			
LP-5881	LYON	217			
LP-81458	MADRYT	110			
LP-563	MAGNETIC BILBAO	192			
LP-561	MAGNETIC LUNAR	192			
LP-559, LP-560	MAGNETIC MOON	194			
LP-555, LP-556	MAGNETIC STAR	193			
LP-557, LP-558	MAGNETIC SUN	191			
LP-8120	MAGNUM SZYNY 3F	187			



Light Prestige Sp. z o.o. Sp.k.

ul. Torowa 45

32-050 Skawina, Polska

tel.: +48 12 333 40 62